



Cottonissima®

Passion for textiles

Din anul 1994, producem cu pasiune
textile hoteliere la standarde europene!



Since 1994, we produce with dedication,
high quality hotel textiles and more...

COTTONISSIMA

Passion for textiles



... din anul 1994

Fondata in anul 1994, ca producator de textile pentru casa, Mod Elle ® Company a devenit un furnizor cu traditie pentru piata romaneasca unde, sub marcile proprii Dormisete ® si Cottonissima ®, colaboreaza cu retailerii, unitati hoteliere, restaurante si institutii de ingrijire.

Crearea unei atmosfere cat mai placuta si relaxanta a unitatii de primire sau a restaurantului dvs., in care oaspetii sa se simta rasfatati, este acum la indemana . Cu experienta de peste 22 de ani in domeniul dotarilor cu textile hoteliere, va putem indruma si propune cele mai potrivite articole care sa asigure atat un confort la standarde europene cat si intretinere economica si rezistenta sporita la folosinta indelungata, in concordanta cu bugetul dvs. alocat acestor dotari.

Pentru definirea ambientului si decorarea camerelor , puteti opta pentru culori calde sau reci, imprimeuri florale, geometrice sau monocrome, lenjerii albe simple sau jaquard, pilote matlasate de primavara-vara/toamna-iarna sau 4 anotimpuri, perne antialergice, protectii pentru saltea, saltele, prosoape si halate albe din Frottier 100% bumbac, draperii, perdele si cuverturi de pat, structura noastra sortimentala cuprinde produse ce se pot adapta oricarui tip de unitate: pensiuni, moteluri, hoteluri 2*-5* . Profesionalismul, promptitudinea si seriozitatea cu care tratam fiecare client sunt trasaturile ce ne definesc iar dorinta de a aduce un plus de confort si design prin alegerea produselor Dormisete, ne motiveaza si ne determina a deveni din ce in ce mai buni.

Avem satisfactia de a asigura produselor noastre raportul optim calitate / pret, tehnologie la standarde europene, materii prime prelucrate prin procedee certificate Oeko Tex si aplicarea sistemului de management al calitatii ISO 9001:2008.

... since 1994

Founded in 1994, as a home textiles producer, Mod Elle Company has become an important local supplier that provides high quality linens under its own brands: Dormisete ® and Cottonissima ® and collaborating with retailers, business-to-business hotels, restaurants, nursery homes, hospitals and care units.

Creating a pleasant and relaxing atmosphere in your hotel and your restaurant where guests feel pampered is very simple. With over 22 years experience in hotel textiles field, we can guide and suggest you the most appropriate items to ensure both comfort to european standard and durable resistance , taking into consideration your budget allocated for these facilities.

Whether you select warm or cool colors , floral or geometrical prints for rooms decoration and high quality linens in white satins , spring-summer duvets, fall-winter or 4 seasons duvets soft, warm and fluffy, hypoallergenic pillows , fitted protectors mattress, mattresses, 100 % cotton white Terry towels, bath mats and robes, curtains and bedspreads, all can be provided by Dormisete.

Our merchandise stands out through the high quality natural fibers and high finishing, resistant and easy to care , contributing to your clients comfort. Our range includes products for any type of unit , hostels , motels, hotels 2 *-5 * .

The professionalism , promptness and seriousness that defines our customer service and the desire to bring more comfort and trendy designs by choosing the Dormisete products, motivates us and lead us to become better every day.

We are proud of our ability to provide home textiles with the optimal quality-price balance and outstanding finish by using high quality materials and implementing the management standard ISO 9001:2008 in our production and logistics.

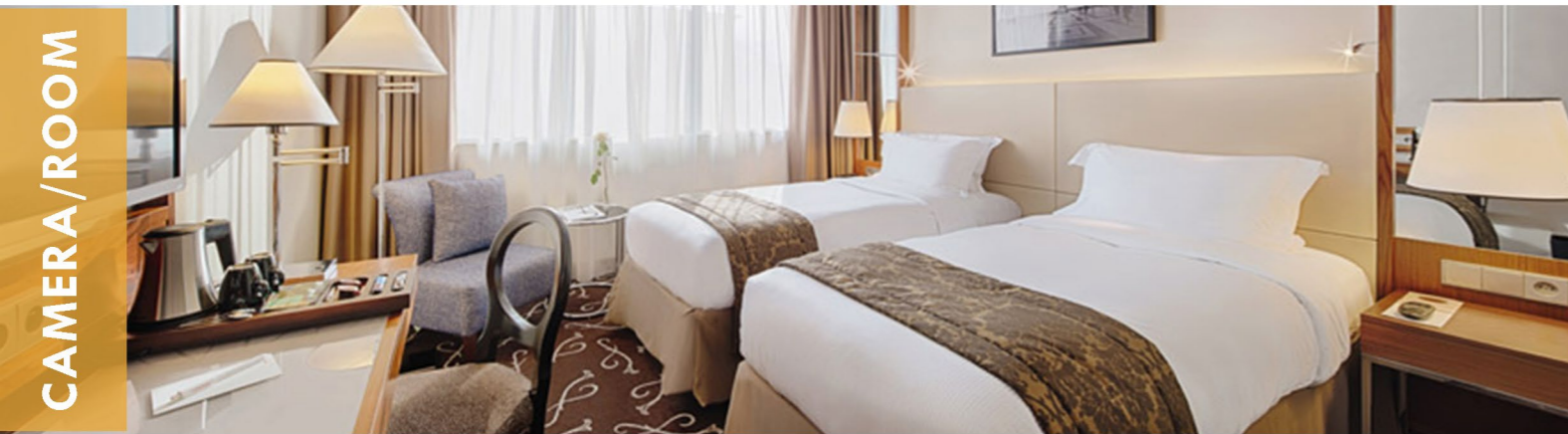

CAMERA/ROOM



BAIE&SPA/BATH&SPA



RESTAURANT

DESPRE/ABOUT

LENJERII DE PAT / BEDLINEN

Colecția Royal / Royal Collection

Compoziție țesătură: 100% bumbac / Fabric blend: 100% Cotton

CAMERĂ/ROOM



RECOMANDAT
HOTELURILOR
DE 4* SI 5*

NOU !

■ SATIN PARIS, JAQUARD

Satin model Jaquard, contextură diagonal 4x1, desime țesătură Ne 260, fir pieptănat, mercerizat, sanforizat pentru stabilitate dimensională (construcție la spălare max. 3%), antipilling, finisaj moale și aspect mătășos, masa țesăturii 135gr./mp.

AVANTAJE : Satin Paris poate fi utilizat cu succes la dotarea celor mai sofisticate locații, putând fi combinat cu Satin Elina Plain (simplu) pentru a obține un efect deosebit .
Lenjeria de pat Satin Paris poate fi confecționată la orice dimensiuni solicitate de client.

■ SATIN PARIS, JAQUARD

Satin Jaquard, blend 100% cotton fabric, combed yarn, mercerised, sanforised, antipilling soft finishing, GSM 135 gr/sqm

ADVANTAGES : Satin Paris can be used successfully with the most sophisticated equipment locations, can be combined with Satin Dhalia Plain in order to achieve a particular decorative effect. The Satin Paris bed linens can be made to measure based on a simple request from the customer.

Cearceaf pat :
Flat sheet :



Husă pat elastic :
Fitted sheet :



Exclusiv la
Dormisete.



MOSTRA
GRATUITA

3
ANI
GARANTIE

CONFIDENCE
IN TEXTILES
Tested for harmful substances
according to Oeko-Tex® Standard 100
02.T.2249
Hohenstein

LENJERII DE PAT / BEDLINEN

Colecția Royal / Royal Collection

Compoziție țesătură: 100% bumbac / Fabric blend: 100% Cotton

CAMERĂ/ROOM



RECOMANDAT
HOTELURILOR
DE 4* SI 5*

NOU !

■ SATIN PARIS, JAQUARD

Satin model Jaquard, contextură diagonal 4x1, desime țesătură Ne 260, fir pieptănat, mercerizat, sanforizat pentru stabilitate dimensională (construcție la spălare max. 3%), antipilling, finisaj moale și aspect mătășos, masa țesăturii 135gr./mp.

AVANTAJE : Satin Paris poate fi utilizat cu succes la dotarea celor mai sofisticate locații, putând fi combinat cu Satin Elina Plain (simplu) pentru a obține un efect deosebit .
Lenjeria de pat Satin Paris poate fi confecționată la orice dimensiuni solicitate de client.

■ SATIN PARIS, JAQUARD

Satin Jaquard, blend 100% cotton fabric, combed yarn, mercerised, sanforised, antipilling soft finishing, GSM 135 gr/sqm

ADVANTAGES : Satin Paris can be used successfully with the most sophisticated equipment locations, can be combined with Satin Dhalia Plain in order to achieve a particular decorative effect. The Satin Paris bed linens can be made to measure based on a simple request from the customer.



Exclusiv la
Dormisete.



MOSTRA
GRATUITA

3
ANI
GARANTIE

CONFIDENCE
IN TEXTILES
Tested for harmful substances
according to Oeko-Tex® Standard 100
02.T.2249
Hohenstein

LENJERII DE PAT / BEDLINEN

Colectia Royal / Royal Collection

Compozitie tesatura: 100% bumbac / Fabric blend: 100% Cotton

LENJERII DE PAT / BEDLINEN

Colectia Royal / Royal Collection

Compozitie tesatura: 100% bumbac / Fabric blend: 100% Cotton

Apreciat de : /Appreciated by :



RECOMANDAT
HOTELURILOR
DE 4* SI 5*

SATIN SCALA CU DUNGI

Satin dungii 2.5+ 0.5, contextura diagonal 4x1, densitate tesatura Ne 300, fir pieptanat, mercerizat, sanforizat pentru stabilitate dimensionala (contractie la spalare max.3%), antipilling, finisaj moale si aspect matasos, masa tesaturii 155gr./mp.

AVANTAJE : Satin Scala poate fi utilizat cu succes la dotarea celor mai sofisticate locatii, putand fi combinat cu Satin Elina Plain (simplu) pentru a obtine un efect deosebit . Lenjeria de pat Satin Scala poate fi confectionata la orice dimensiuni solicitate de client.

SATIN SCALA STRIPES

Satin stripes 2.5+0.5 cm, blend 100% cotton fabric, combed yarn, mercerised, sanforised, antipilling soft finishing, GSM 155 gr/sqm

ADVANTAGES : Satin Scala can be used successfully with the most sophisticated equipment locations, can be combined with Satin Elina Plain in order to achieve a particular decorative effect . The Satin Scala bed linen can be made to measure based on a simple request from the customer .

Cearceaf pat :
Flat sheet :



Husa pat elastic :
Fitted sheet :



Alese de : /Selected by :



Exclusiv la
Domiseto®



Fabricat in
România



RECOMANDAT
HOTELURILOR
DE 4* SI 5*

SATIN PLAIN ELINA

O tesatura Plain de o calitate deosebita, cu contextura diagonal 4x1 cu fire pieptanate, compozitie 100% bumbac, cu masa de 155gr./mp. Datorita procesului de mercerizare este asigurata antipilling, luciu placut, finisare moale si aspect matasos si sanforizare (contractie la spalare max.3%).

AVANTAJE : Satin Elina poate fi utilizat cu succes la dotarea celor mai sofisticate locatii, putand fi combinat cu Satin Scala dungii pentru a obtine un efect deosebit . Lenjeria de pat Satin Elina poate fi confectionata la orice dimensiuni solicitate de client.

SATIN PLAIN ELINA

Plain fabric of outstanding quality , with textures diagonal 4 x 1 with worsted , composition 100 % cotton with a weight of 155gr . / Sqm . Due process is ensured Mercerizing antipilling , nice luster , soft and silky finish and sanforizing (washing max.3 % contraction) .

ADVANTAGES : Satin Elina can be used successfully with the most sophisticated equipment locations can be combined with Satin stripes Scala in order to achieve a particular decorative effect. These article can be made to measure based on a simple request from the customer .



Exclusiv la
Domiseto®



Fabricat in
România



Lenjerii exclusive pentru cei mai pretentiosi clienti! / Exclusive bedlinen for most demanding clients!

O tesatura Plain de o calitate deosebita! / Plain fabric of outstanding quality !

LENJERII DE PAT / BEDLINEN

Colectia Royal / Royal Collection

Compozitie tesatura: 50% bumbac+50% poliester / Fabric blend: 50% Cotton+50% Poliester

CAMERA/ROOM



RECOMANDAT
HOTELURILOR
DE 4* SI 5*

SATIN MILANO CU DUNGI

Satin dungii 2.5+ 0.5 cm latime, contextura diagonal 4x1, compozitie 50% bumbac si 50% polyester cu densitate tesatura Ne 300, „mercerizat, sanforizat, easy care pentru intretinere facila, finisaj moale si aspect matasos, masa tesaturii 155gr./mp., sanforizare pentru stabilitate dimensionala.

AVANTAJE : Satin Milano poate fi utilizat cu succes la dotarea celor mai sofisticate locatii, putand fi combinat cu Satin Roma Plain (simplu) pentru a obtine un efect deosebit . Lenjeria de pat Satin Milano poate fi confectionata la orice dimensiuni solicitate de client.

SATIN MILANO STRIPES

Satin Milano stripes 2.5+0.5 cm, 4x1, blend 50% cotton 50% polyester fabric, mercerised, sanforised, antipilling, easy care, soft finishing, GSM 155 gr/sqm

ADVANTAGES : Satin Milano can be used successfully with the most sophisticated equipment locations, can be combined with Satin Roma Plain in order to achieve a particular decorative effect. The Satin Milano bed linen can be made to measure based on a simple request from the customer.

Cearceaf pat :
Flat sheet :



Husa pat elastic :
Fitted sheet :



Alese de : /Selected by :



Exclusiv la
Dorniseto®



MOSTRA
GRATUITA

3 ANI
GARANTIE



LENJERII DE PAT / BEDLINEN

Colectia Royal / Royal Collection

Compozitie tesatura: 50% bumbac+50% poliester / Fabric blend: 50% Cotton+50% Poliester

CAMERA/ROOM



RECOMANDAT
HOTELURILOR
DE 4* SI 5*

Alese de :
Selected by :

Vila BERLIN

Cearceaf pat :
Flat sheet :



Husa pat elastic :
Fitted sheet :



SATIN PLAIN ROMA

O tesatura Plain de o calitate deosebita, cu contextura diagonal 4x1 cu fire pieptanate, compozitie compozitie 52% bumbac si 48 % polyester, cu masa de 155gr./mp. Datorita procesului de mercerizare este asigurata antipilling, cu tratament easy care pentru intretinere facila, luciu placut, finisare moale si aspect matasos si sanforizare pentru stabilitate dimensionala (contractie la spalare max.3%).

AVANTAJE : Satin Roma poate fi utilizat cu succes la dotarea celor mai sofisticate locatii, putand fi combinat cu Satin Milano dungii pentru a obtine un efect deosebit . Lenjeria de pat Satin Roma poate fi confectionata la orice dimensiuni solicitate de client.

SATIN PLAIN ROMA

Plain fabric of outstanding quality , with textures diagonal 4 × 1 blend 52% cotton and 48% polyester, GSM 155gr . / Sqm . Due mercerization process it is ensured the antipilling fastness, fine luster , soft and silky finish and sanforization for stability (washing max.3 % contraction) .

ADVANTAGES : Satin Roma can be used successfully with the most sophisticated equipment locations, can be combined with Satin Milano Stripes in order to achieve a particular decorative effect. It can be made to measure based on customer request.



Exclusiv la
Dorniseto®



MOSTRA
GRATUITA

3 ANI
GARANTIE



Easy care pentru intretinere facila! / Easy care, for best results!

Luciu placut, finisare moale si aspect matasos! / Fine luster , soft and silky finish!

LENJERII DE PAT / BEDLINEN

Colectia Premium / Premium Collection

Compozitie tesatura: 100% bumbac / Fabric blend: 100% Cotton

CAMERA/ROOM



■ SATIN TRIANA CU DUNGI

Satin dungii 1.4 cm latime, 4x1, densitate tesatura 230, fir mercerizat, sanforizat, finisaj moale si aspect matasos, masa tesaturii 155gr./mp, finisare speciala pentru uz hotelier.

AVANTAJE : Satin Triana este recomandat unitatilor cu trafic intens, fiind o tesatura rezistenta fabricate dintr-un fir mai plin. Modelul cu dungii egale ofera eleganta produselor confectionate din aceasta tesatura si poate fi combinat cu Satin Dhalia Plain pentru un efect deosebit. Lenjeria de pat Satin Triana poate fi confectionata la orice dimensiuni solicitate de client.

■ SATIN TRIANA STRIPES

Satin stripes 1.4 cm, 4x1, TC 230, sanforised, soft finishing, GSM155 gr/sqm, special finish for professional use.

ADVANTAGES : Satin Triana is recommended for intensive Laundry units being manufactured with a ticker yarn and a compact construction fabric. The stripes design is very elegant. It can be combined with Satin Dhalia Plain in order to achieve a particular decorative effect. The Satin Triana can be made to customer measure.

Cearceaf pat :
Flat sheet :

Husa pat elastic :
Fitted sheet :

Alese de : /Selected by :



Racova Hotel

Select



Relax Comfort Suites
HOTEL ****
by Relax



Exclusiv la
Dorniseto



MOSTRA
GRATUITA

3
ANI
GARANTIE



LENJERII DE PAT / BEDLINEN

Colectia Premium / Premium Collection

Compozitie tesatura: 100% bumbac / Fabric blend: 100% Cotton

CAMERA/ROOM



RECOMANDAT
HOTELURILOR
DE 3* SI 4*

Cearceaf pat :
Flat sheet :



Husa pat elastic :
Fitted sheet :



■ SATIN PLAIN DHALIA

Satin Plain(neted) 4x1, densitate tesatura 230, fir mercerizat, sanforizat, finisaj moale si aspect matasos, masa tesaturii 165gr./mp, finisare speciala pentru uz hotelier.

AVANTAJE : Satin Dhalia este recomandat unitatilor cu trafic intens, fiind o tesatura rezistenta fabricata dintr-un fir mai plin si avand o finisare speciala pentru rezultate deosebite la calcare. Modelul simplu Plain ofera eleganta produselor confectionate din aceasta tesatura si poate fi combinat cu Satin Triana dungii pentru un efect remarcabil. Lenjeria de pat Satin Dhalia poate fi confectionata la orice dimensiuni solicitate de client.

■ SATIN PLAIN DHALIA

Satin Plain 4x1, TC 230, sanforised, soft finishing, GSM165 gr/sqm, special finish for professional use.

ADVANTAGES : Satin Dhalia is recommended for intensive laundry units being manufactured with a ticker yarn and a compact construction fabric. With a simple and smooth surface is very elegant. It can be combined with Satin Triana Stripes in order to achieve a particular decorative effect. The Satin Dhalia can be made to required measures.



Exclusiv la
Dorniseto



MOSTRA
GRATUITA

3
ANI
GARANTIE



Recomandat unitatilor cu trafic intens. / It is recommended for intensive Laundry units .

Se confectioneaza la orice dimensiuni solicitate de client. / Is manufactured in any size required by the customer .

LENJERII DE PAT / BEDLINEN

Colecția Premium / Premium Collection

Compoziție țesătură: 100% bumbac / Fabric blend: 100% Cotton

CAMERĂ/ROOM



RECOMANDAT
HOTELURILOR
DE 3* SI 4*

SATIN ASTRA CU DUNGI

Satin dungi 2 cm lățime, 100% bumbac cu contextură diagonal 4x1, densitate țesătură 230, fir mercerizat, sanforizat, finisaj moale și aspect mătășos, masa țesăturii 155gr./mp, finisare specială pentru uz hotelier.

AVANTAJE : Satin Astra este recomandat unităților cu trafic intens, fiind o țesătură rezistentă, fabricată dintr-un fir mai plin și poate fi combinat cu Satin Dhalia Plain pentru un efect deosebit. Lenjeria de pat Satin Astra poate fi confecționată la orice dimensiuni solicitate de client.

SATIN ASTRA STRIPES

Satin stripes 1.4 cm, 4x1, 100% cotton TC 230, sanforised, soft finishing, GSM155 gr/sqm, special finish for professional use.

AVANTAGES : Satin Astra is recommended for intensive Laundry units being manufactured with a ticker yarn and a compact construction fabric. It can be combined with Satin Dhalia Plain. It can be made to measure based on a simple request from the customer.



Cearceaf pat :
Flat sheet :



Husă pat elastic :
Fitted sheet :



Exclusiv la
Dormiseto



Fabricat în
România

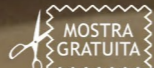

LENJERII DE PAT / BEDLINEN

Colectia Premium / Premium Collection

Compoziție țesatura: 50% bumbac+50% poliester / Fabric blend: 50% Cotton+50% Poliester



RECOMANDAT
HOTELURILOR
DE 3* SI 4*

Alese de :
Selected by :



VILA *** CARLOS



HOTEL NEMIRA****

Cearceaf pat :
Flat sheet :



Husă pat elastic :
Fitted sheet :



CAMERĂ/ROOM

PERCALE ONDA

Percale Onda este o țesatura Policotton cu compoziție 50% bumbac și 50% polyester,, foarte rezistentă, desime 230 fire, fabricată din fire pieptanate masa țesăturii 145gr./mp., mercerizată, sanforizată (stabilitate dimensională după spălare), antipilling , easy care.

AVANTAJE : Aceasta țesatura este utilizată cu succes în industria hotelieră mondială, fiind recunoscută ca o țesatura foarte practică și rezistentă. cu o tinută deosebită. Mentine un aspect deosebit de apretare .

PERCALE ONDA

Percale Onda is a Policotton fabric made of combed yarn blend 50% cotton and 50% Polyester% , TC 230,GSM 145gr/Sqm . mercerized, sanforised, antipilling, easy care.

ADVANTAGES : This fabric is used successfully in the global hospitality industry , being recognized as a very practical and resistant fabric due to compact construction and very elegant .



Exclusiv la
Dormiseto



Fabricat în
România



Țesătură sanforizată (contractie la spălare max. 2%). / Sanforised fabric (shrinkage max. 2%).

Recunoscută ca o țesatura foarte practică și rezistentă. / It's being recognized as a very practical and resistant fabric.

LENJERII DE PAT / BEDLINEN

Colecția Premium / Premium Collection

Compoziție țesătură: 50% bumbac+50% poliester / Fabric blend: 50% Cotton+50% Poliester

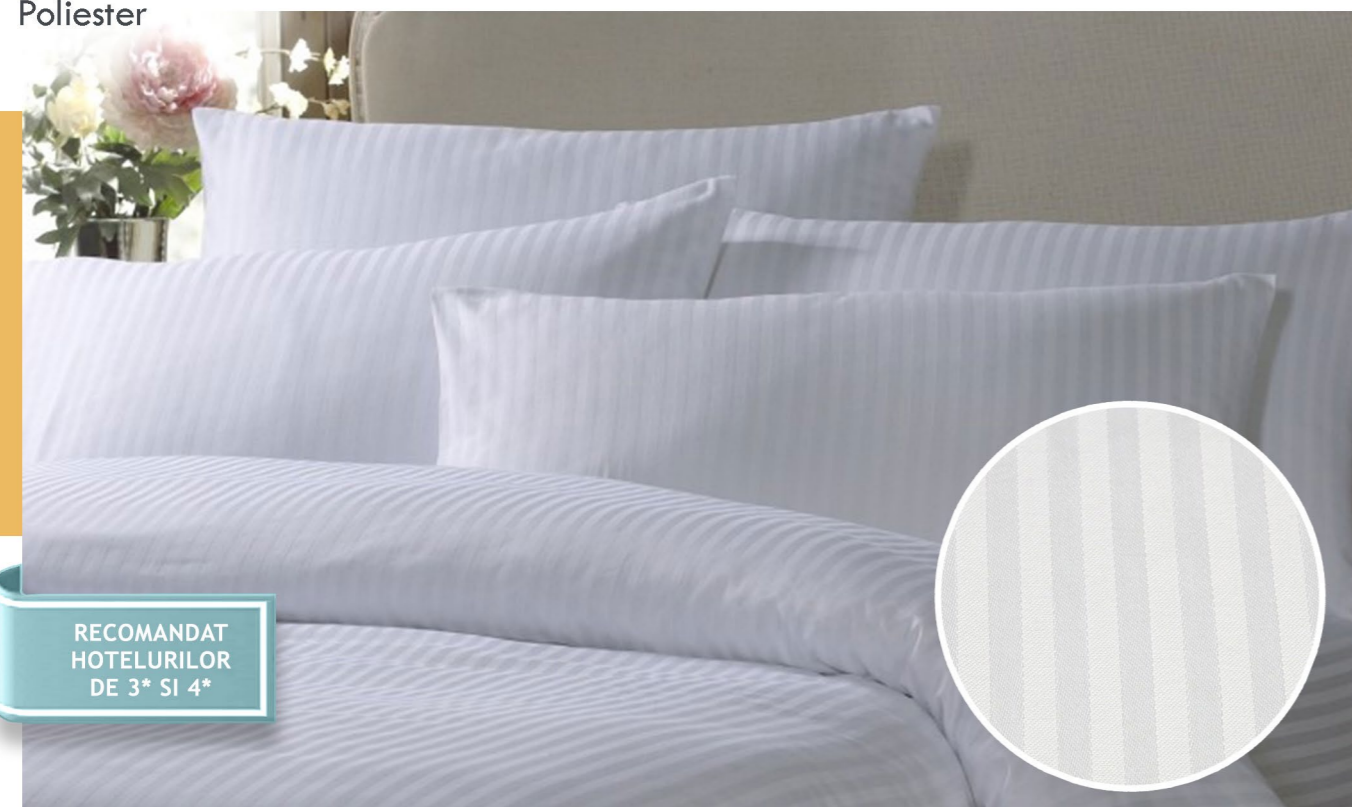

■ SATIN BARI CU DUNGI

Țesătură Jaquard cu dungi de 1cm, contextură diagonală 4x1, compoziție 50% bumbac + 50% poliester, cu masa de 155gr./mp. Finisarea specială pentru uz hotelier a țesăturii asigură un tuseu moale, fin; este tratată antipilling, mercerizată și sanforizată, articolele păstrându-și stabilitatea dimensională, easy care.

AVANTAJE : Rezistență la folosire îndelungată, se calcă ușor datorită conținutului de polyester. Lenjeria de pat Satin Bari poate fi confecționată la orice dimensiuni solicitate de client.

■ SATIN BARI STRIPES

Satin Bari stripes 1cm, fabric diagonal 4 x 1, blend 50 % cotton + 50 % polyester, weight 155gr/Sqm. Special finishing for industrial laundry, easy care, antipilling, mercerized and sanforised, for dimensional stability. Can be mixed with Satin Roma Plain for a particular decorative effect.

ADVANTAGES : Resistance to extended use, easy to iron because it contains polyester. The Satin Bari bed linen can be made to measure based on a simple request from the customer.



Cearceaf pat :
Flat sheet :



Husă pat elastic :
Fitted sheet :



Exclusiv la
Dormiseto®



MOSTRA
GRATUITA

3 ANI
GARANTIE



LENJERII DE PAT / BEDLINEN

Colecția Premium / Premium Collection

Compoziție țesătură: 50% bumbac+50% poliester / Fabric blend: 50% Cotton+50% Poliester



■ SATIN CORSICA CU DUNGI

Tesatura Jaquard cu dungi de 3cm, contextura diagonală 4x1 cu fire pieptanate, compoziție 50% bumbac + 50% poliester, cu masa de 155gr./mp. Finisarea specială pentru uz hotelier a țesăturii asigură un tuseu moale, fin, antipilling, mercerizată și sanforizată, articolele păstrându-și stabilitatea dimensională.

AVANTAJE : Rezistență la folosire îndelungată, se calcă ușor datorită conținutului de polyester.

■ SATIN CORSICA STRIPES

Satin Corsica stripes 3cm, fabric diagonal 4 x 1, blend 50 % cotton + 50 % polyester, weight 155gr/Sqm. Special finishing for industrial laundry, easy care, antipilling, mercerized and sanforised, for dimensional stability. Can be mixed with Satin Roma Plain for a particular decorative effect.

AVANTAGES : Resistance to intensive use, easy to iron because the polyester portion.

Cearceaf pat :
Flat sheet :



Husă pat elastic :
Fitted sheet :



Exclusiv la
Dormiseto®



MOSTRA
GRATUITA

3 ANI
GARANTIE



Recomandat unităților cu trafic intens. / It is recommended for intensive Laundry units.

Tesatura sanforizata (contractie la spalare max. 2%). / Sanforised fabric (shrinkage max. 2%).

LENJERII DE PAT / BEDLINEN

Colectia Basic / Basic Collection

Compozitie tesatura: 100% bumbac / Fabric blend: 100% Cotton

CAMERA/ROOM

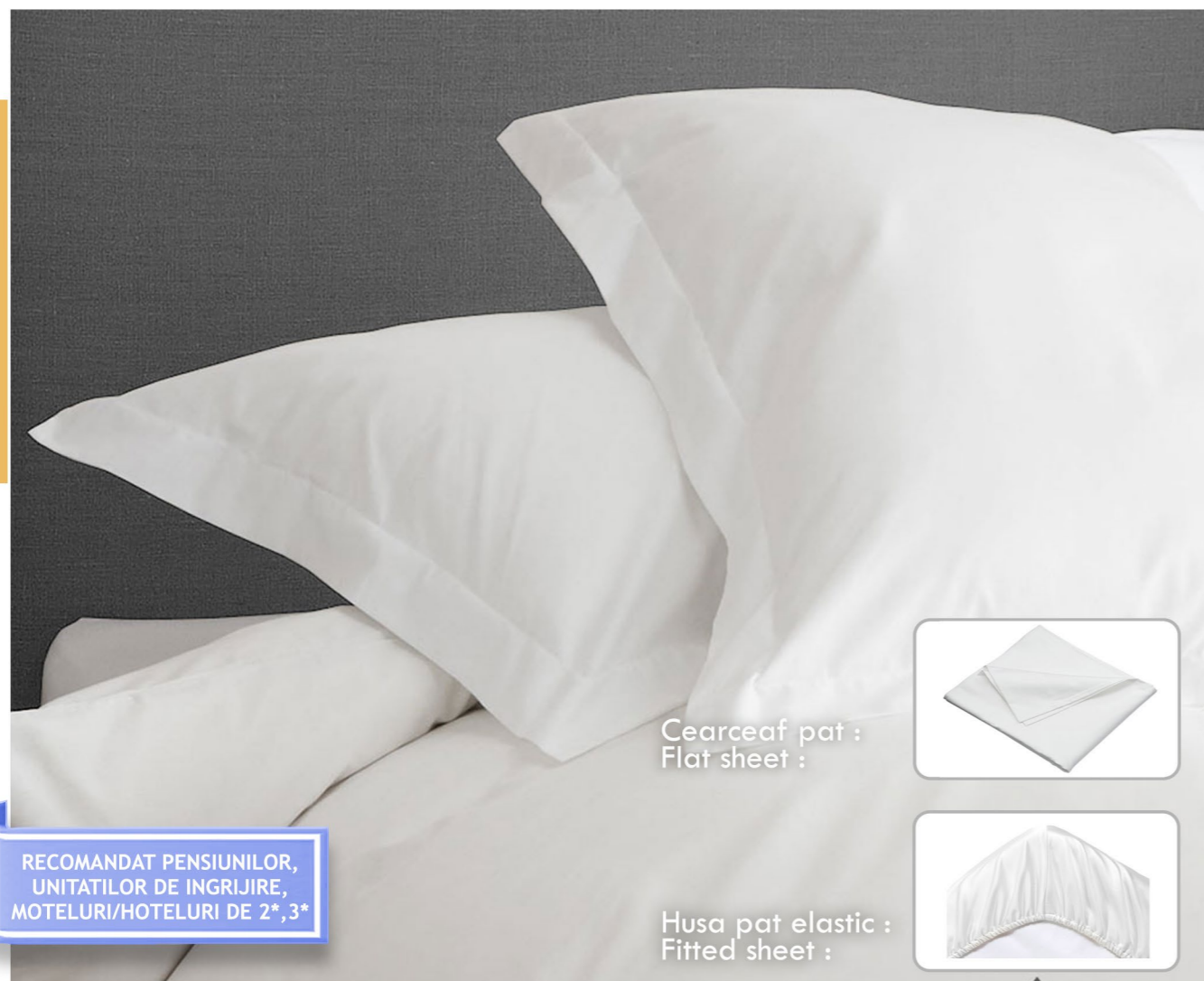

Cearceaf pat :
Flat sheet :



Husa pat elastic :
Fitted sheet :



RECOMANDAT PENSIUNILOR,
UNITATILOR DE INGRIJIRE,
MOTELURI/HOTELURI DE 2*,3*

■ COTTON HARDY

Tesatura neteda, 1x1 legatura panza, TC 130, 100% bumbac, masa tesaturii 150gr/mp, sanforizata (stabilitate dupa spalare), contractie max. 3%, cu fir plin si rezistent .

AVANTAJE : Fiind o varianta economica, lenjeria de pat Cotton Hardy este solutia eficienta in dotarea pensiunilor, motelurilor, hotelurilor de 2*-3*, bazelor de tratament si unitatilor de ingrijire. Lenjeria de pat Cotton Hardy poate fi confectionata la orice dimensiuni solicitate de client.

■ COTTON HARDY

Plain fabric 1 x 1 , TC 130, 50% cotton and 50% polyester weight 150gr/sqm, sanforised (stability after washing), shrinkage max. 3%, ticker yarn very resistant to intensive use, easy ironing due to its combination cotton & polyester.

ADVANTAGES : As a budget option, Cotton Hardy bedding is effective in equipping motels, mansions, hotels 2*-3 * , nurseries and care units. Cotton Hardy bedlinen can be made to required measures.



Exclusiv la
Dormiseto®



MOSTRA
GRATUITA

3
ANI
GARANTIE



LENJERII DE PAT / BEDLINEN

Colectia Basic / Basic Collection

Compozitie tesatura: 100% bumbac / Fabric blend: 100% Cotton

CAMERA/ROOM



Cearceaf pat :
Flat sheet :



Husa pat elastic :
Fitted sheet :



RECOMANDAT PENSIUNILOR,
UNITATILOR DE INGRIJIRE,
MOTELURI/HOTELURI DE 2*,3*

■ RENFORCE CHANDI

Tesatura neteda 1x1 legatura panza, TC 145, cu o compozitie 100% bumbac, masa tesatura 125gr./mp., sanforizata (are stabilitate dimensionala dupa spalare), are tratament antipilling, un tuseu moale si placut.

AVANTAJE : Fiind varianta economica, lenjeria de pat Chandi este solutia ideala pentru dotarea pensiunilor, unitatilor de ingrijire, moteluri si hoteluri de 2*-3 *.

■ RENFORCE CHANDI

Renforce plain, blend 100% cotton fabric, 1X1, TC 145, sanforised, antipilling. soft finishing, GSM125 gr/sqm.

ADVANTAGES : As a budget option, the Renforce Chandi is the ideal solution for motels, guest house, 2-3* hotels, hospitals, care and nursery units.



Exclusiv la
Dormiseto®



MOSTRA
GRATUITA

3
ANI
GARANTIE



LENJERII DE PAT / BEDLINEN

Colectia Basic / Basic Collection

Compozitie tesatura: 100% bumbac / Fabric blend: 100% Cotton

CAMERA/ROOM



Cearceaf pat / Flat sheet :



Husa pat elastic / Fitted sheet :



RECOMANDAT PENSIUNILOR,
UNITATILOR DE INGRIJIRE,
MOTELURI/HOTELURI DE 2*,3*

■ CREPE ALB

Lenjeria de pat din tasatura creponata alba legatura panza 1x1 TC 145, masa tesatura 125gr/mp, fiind ideala pentru utilizare intensiva deoarece este rezistenta si nu necesita calcare, astfel asigurand o economie insemnata .

AVANTAJE : Tesatura Crepe cu compozitie 100% bumbac are un grad mare de rezistenta datorita densitatii generoase asigurand astfel confort si aspect placut, este sanforizata (are stabilitate dimensionala dupa spalare), cu tratament antipilling si albire optica.este ideala pentru unitatile cu spalatorie proprie.

■ SEERSUCKER OPTICAL WHITE

The seersucker bed linen , blend 100% cotton fabric, 1X1 Renforce TC 145, GSM 125gr/sqm, no ironing, soft finishing.

ADVANTAGES : Seersucker fabric with 100 % cotton composition has a high resistance due generous density ensuring comfort and pleasant appearance, is sanforised (dimensional stability after washing) is antipilling and optical bleaching treatment . Due to no ironing finish , this fabric is the best option for small units with in house laundry.



Exclusiv la
Domiseto



MOSTRA
GRATUITA

3 ANI
GARANTIE



LENJERII DE PAT / BEDLINEN

Colectia Basic / Basic Collection

Compozitie tesatura: 50% bumbac+50% poliester / Fabric blend: 50% Cotton+50% Poliester

CAMERA/ROOM



Cearceaf pat :
Flat sheet :

Husa pat elastic :
Fitted sheet :

RECOMANDAT PENSIUNILOR,
UNITATILOR DE INGRIJIRE,
MOTELURI/HOTELURI DE 2*,3*

■ PC HARDY

Tesatura neteda, 1x1 legatura panza, TC 130, 50% bumbac + 50% poliester masa tesaturii 150gr/mp, sanforizata (stabilitate dupa spalare), contractie max. 3%, cu fir plin, usor de calcat si rezistent datorita combinatiei firului bumbac si poliester.

AVANTAJE : Fiind o varianta economica, lenjeria de pat PC Hardy este solutia eficienta in dotarea pensiunilor, motelurilor, hotelurilor de 2*-3*, bazelor de tratament si unitatilor de ingrijire. Lenjeria de pat PC Hardy poate fi confectionata la orice dimensiuni solicitate de client.

■ PC HARDY

Plain fabric 1x1, TC 130, 50% cotton and 50% polyester weight 150gr/sqm, sanforised (stability after washing), shrinkage max. 3%, ticker yarn very resistant to intensive use, easy ironing due to its combination cotton & polyester.

ADVANTAGES : As a budget option, PC Hardy bedding is effective in equipping motels, mansions, hotels 2*-3*, nurseries and care units. PC Hardy bedlinen can be made to required measures.



Exclusiv la
Domiseto



MOSTRA
GRATUITA

3 ANI
GARANTIE



Lenjerii rezistente care nu necesita calcare! / Resistant linen no ironing !

Se confectioneaza la orice dimensiuni solicitate de client. / Is manufactured in any size required by the customer .

Detalii tehnice / Technic details

Tipuri de husa pentru perna / Pillow case types

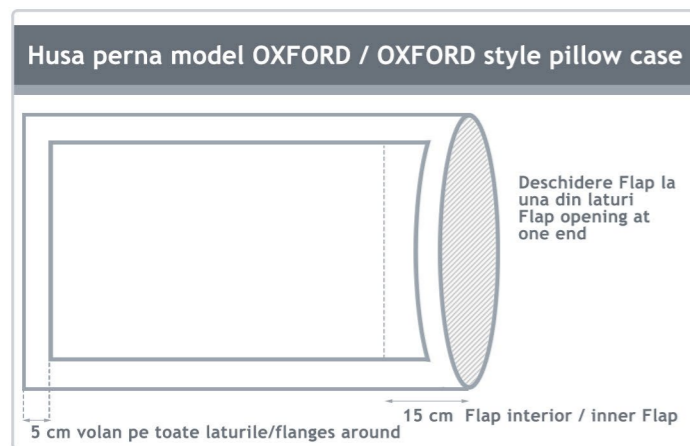

AVANTAJE : Acest model de fata perna este practic si decorativ. Se preteaza tesaturilor simple fara dungii.

ADVANTAGES : This pillow case model is practice and very decorative. Suitable for Plain Fabrics.

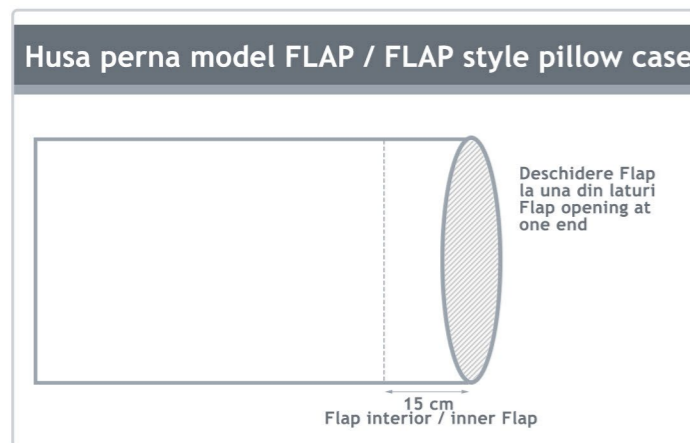
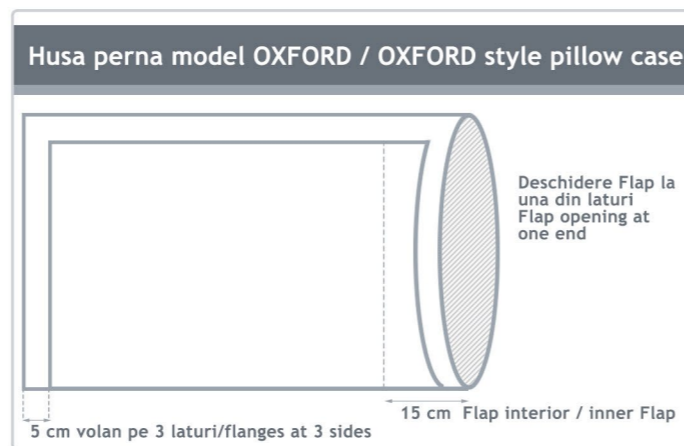

AVANTAJE : Modelul Flap este foarte practica fixand perfect perna in interior.

ADVANTAGES : The model is very practical because the Flap keep the pillow inside the case perfectly.

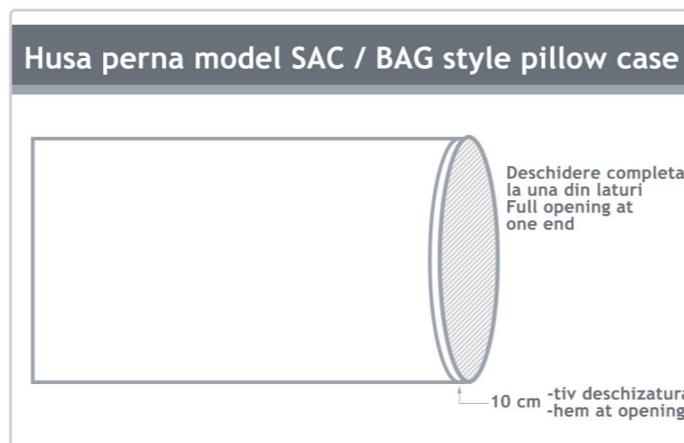

AVANTAJE : Acesta este un model practice si economic ce asigura imbracarea rapida a pernei.

ADVANTAGES : This is the most practical model for a fast and easy fitting of the pillow.

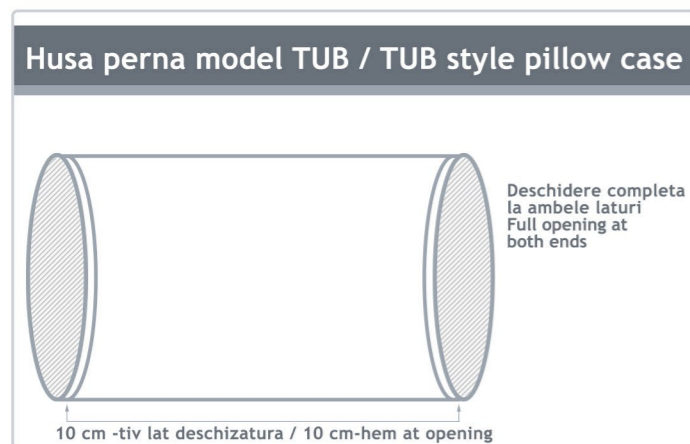

AVANTAJE : Acesta este cel mai practic model, cele doua deschideri permit imbracarea rapida a pernei.

ADVANTAGES : It is the most practical model, the two openings enable a quick fitting of the pillow.

Huse pentru perne practice si economice. / Pillow cases practical and economical .

Detalii tehnice / Technic details

Tipuri de huse pentru pilota / Duvet cover types

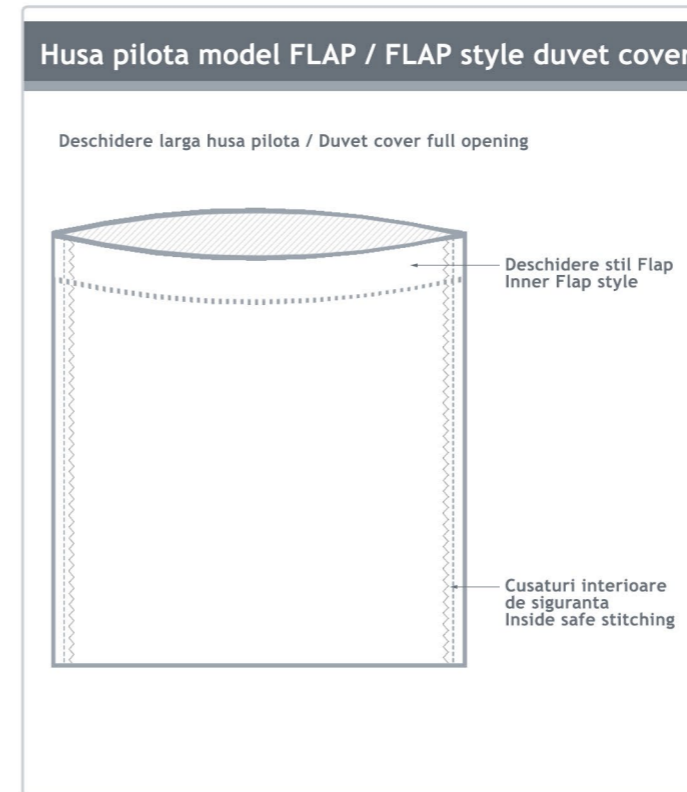

AVANTAJE : Acest model de husa usureaza semnificativ munca guvernantei datorita orificiilor laterale ce permit introducerea cu usurinta a pilotei in husa si fixarea ei pe culturi.

ADVANTAGES : This duvet cover model eases significant the housekeeper work because the holes on both sides allowing easy fitting of the duvet in the opposite corners of the duvet cover.

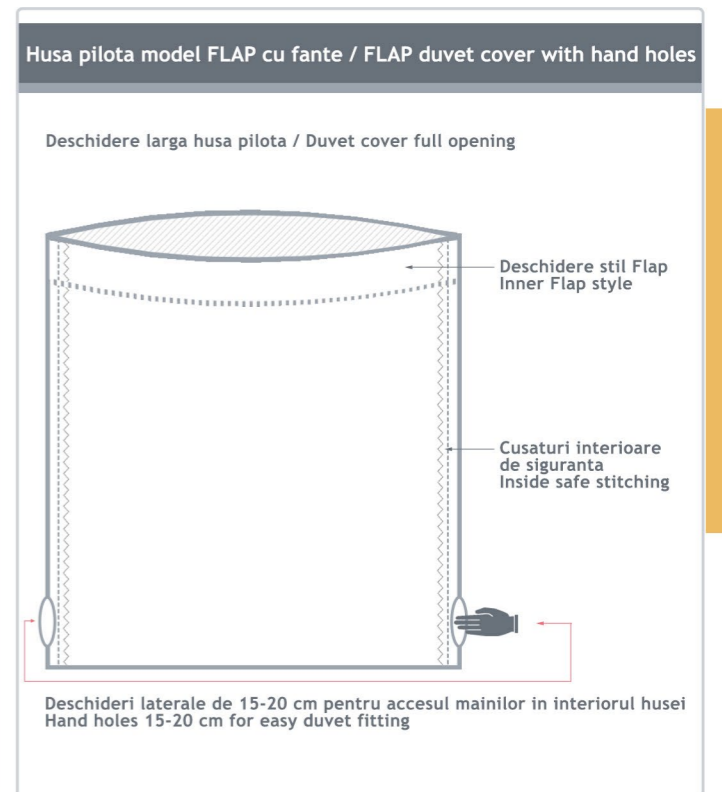
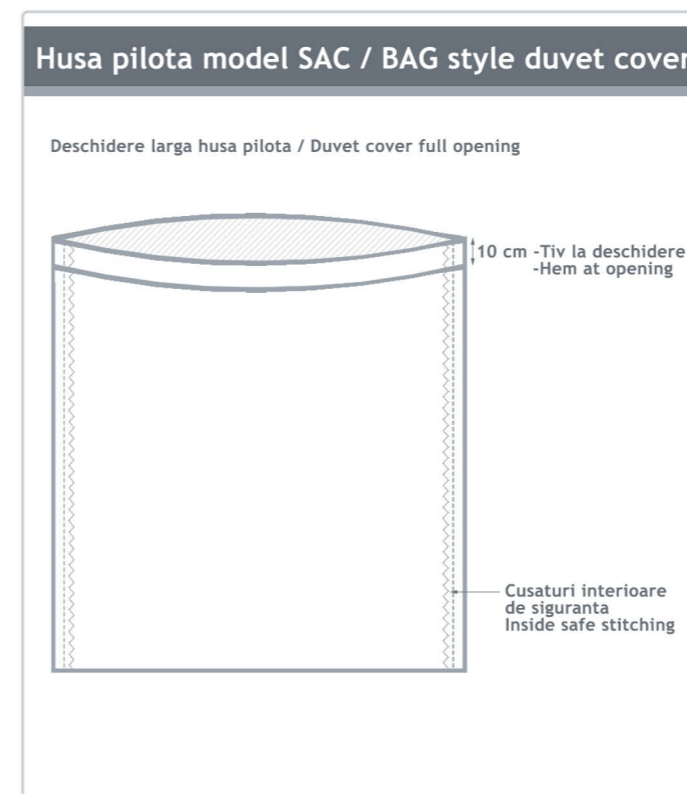

AVANTAJE :

Acest model de husa este cel mai practic deoarece deschiderea husei este larga, nu are flap iar introducerea pilotei si aranjarea ei in interiorul husei se face foarte usor si rapid.

ADVANTAGES :

This duvet cover model is the most practical because the opening is wide, it has no flap and the placing of duvet inside can be done very easy and fast.

Husa pilota cu are orificii laterale facilitand aranjarea. / Duvet cover has side holes facilitating arrangement .

Detalii tehnice / Technic details

Tipuri de cearceaf pentru pat / Bed sheet types

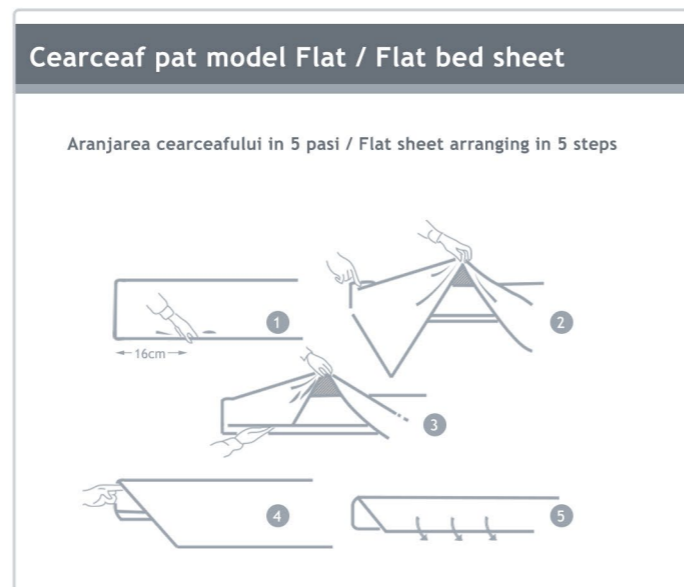
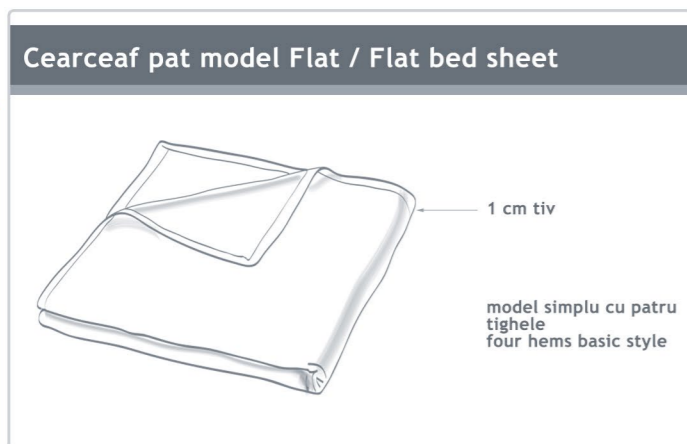

AVANTAJE : Cearceaful de pat model Flat(intins) este cel mai folosit si cel mai practic deoarece poate fi folosit pe diverse dimensiuni de saltele. Se poate ajusta prin simpla introducere a acestuia sub saltea. Pentru o aranjare perfecta pe saltea se recomanda dimensiuni cu 40cm mai mari fata de cele ale saltelei.

ADVANTAGES : The bed sheet model Flat is the most used and most practical because it can be used on various sizes of mattresses. It may be adjusted by simply inserting it under the mattress. For a perfect fit on the mattress is recommended a sheet size 40cm wider on each side than those of the mattress.

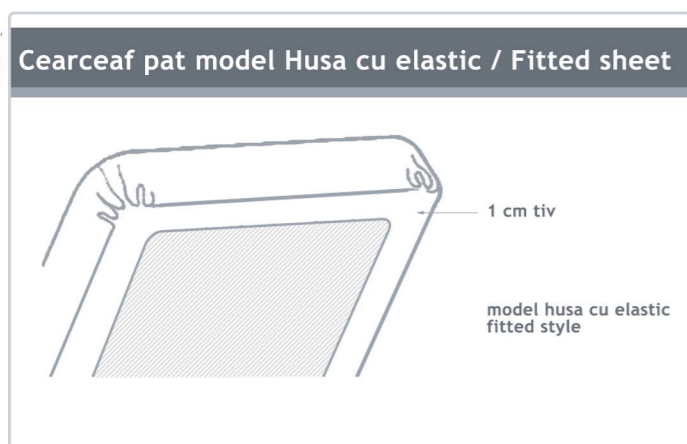

AVANTAJE : Husa de pat cu elastic este practica si se fixeaza perfect de saltea. Este mai putin folosita in industria hoteliera datorita benzii elastice care ingreuneaza procesul de calcare la calandru.

ADVANTAGES : The fitted sheet is practical and perfect fit on the mattress . It is less used in the hospitality industry due to elastic band slowing down the process of ironing calender and less resistance.

PERNE ANTIALERGICE/ANTIALLERGIC PILLOWS

Colectia Royal / Royal Collection

Umplutura: Nanofibra / Filling: Nanofiber



PERNA ANTIALERGICA DIN NANOFIBRA

O perna superioara cu tesatura din bumbac 100% si umplutura Nanofibră, aceasta fiind cea mai fină și rezistentă fibra dintre fibrele sintetice cunoscute. Este singura fibră sintetică similara cu proprietățile pufului de gâscă.

AVANTAJE : Oferă susținere fără agresiune a zonei cervicale. Nanofibra asigura confort termic, moliciune, elasticitate, ventilație. În plus, este perfectă pentru cei alergici. Perna din nanofibra este pufoasă, antialergică și lavabilă.

NANOFIBER PILLOW

A high quality pillow made with 100% cotton fabric and Nanofiber filling, which is the finest, resilient fiber among the polyester fibers. It is the only polyester fiber with similar properties of goose down and feathers.

ADVANTAGES : It gives support to the cervical area without aggression . Nanofibres ensure thermal comfort softness , elasticity , ventilation . In addition, it is perfect for those with allergies . pillows nanofibres is fluffy , antiallergic and washable .



Exclusiv la
Dormiseto

Fabricat în
România

MOSTRA
GRATUITA

3 ANI
GARANTIE

CONFIDENCE
IN TEXTILES
Tested for harmful substances
according to Oeko-Tex® Standard 100
02.T.2249
Hohenstein

PERNE ANTIALERGICE / ANTIALLERGIC PILLOWS

Colectia Premium / Premium Collection
Umplutura: Microfibra / Filling: Microfiber

CAMERA/ROOM

RECOMANDAT
HOTELURILOR
DE 3* SI 4*



PERNA ANTIALERGICA CU MICROFIBRA

O perna de calitate, fabricata cu tesatura din Satin bumbac 100% si umplutura Microfibra 100% polyester siliconat, poate fi produsa la orice dimensiune. Este o fibră sintetică elastica, cu grad mare de revenire la forma initiala.

AVANTAJE : Oferă susținere fără agresiune a zonei cervicale. Confectionate din tesatura superioara de Satin neted sau cu model dungii, din bumbac 100%, mercerizat. Perfectă pentru cei alergici. Perna cu Microfibra este pufoasă, antialergică, lavabilă, ideala folosirii intensive.

MICROFIBER PILLOW

The Microfiber pillows are made of 100% cotton Satin Plain or Stripes, soft and silky, filled with 100% polyester Microfiber siliconed, lightweight, washable, antiallergic, very elastic maintaining its original shape .

ADVANTAGES : It gives support to the cervical area without aggression . Upper made of fabric Satin smooth or patterned stripes from 100% cotton mercerized . In addition, it is perfect for those with allergies . Microfiber fluffy pillow is antiallergic and washable .



Exclusiv la
Dormiseto®



MOSTRA
GRATUITA

3
ANI
GARANTIE



Microfibra este pufoasă, antialergică și lavabilă. / The Microfiber is fluffy, elastic, antiallergic and washable.

PERNE ANTIALERGICE / ANTIALLERGIC PILLOWS

Colectia Basic / Basic Collection
Umplutura PUF 100% poliester / Filling: polyester fiber 100%

CAMERA/ROOM



RECOMANDAT PENSUNILOR,
UNITATILOR DE INGRIJIRE,
MOTELURI/HOTELURI DE 2*, 3*

PERNA ANTIALERGICA DE PUF 100% POLIESTER SILICONIC

Pernele sunt confectionate din tesatura Renforce din bumbac alb 100%, cu umplutura de de fibra 100% poliester siliconic,, lavabila si antialergica. Acest model de perna poate fi confectionat la orice dimensiuni solicitate de client.

AVANTAJE : Perna umpluta cu puf poliester este perfectă pentru cei alergici. Aceasta umplutura este pufoasă, hipoalergenică și lavabilă. Este cea mai economica varianta de perna antialergica.

100% POLYESTER FIBER ANTIALERGIC PILLOW

The antiallergic pillow made of 100% cotton fabric Renforce and 100% polyester silicone filling is washable and antiallergic .

ADVANTAGES : This pillow is resistant, washable and antiallergic. This pillow is the most economic option.



Exclusiv la
Dormiseto®



MOSTRA
GRATUITA

3
ANI
GARANTIE



Cea mai economica varianta de perna antialergica./ This pillow is the most economic option.

Detalii tehnice / Technic details

Tipuri de perne / Pillows types



AVANTAJE : Consistenta Nanofibreii se apropie foarte mult de caracteristicile pernei umplute cu puf de gâscă, aceasta fiind concepută pentru a asigura un suport corect al zonei cervicale și o permeabilitate crescută a aerului.

ADVANTAGES : The consistency of Nanofiber is very close to goose down and feather, which is designed to ensure the correct support of the cervical and a high air permeability during sleep.

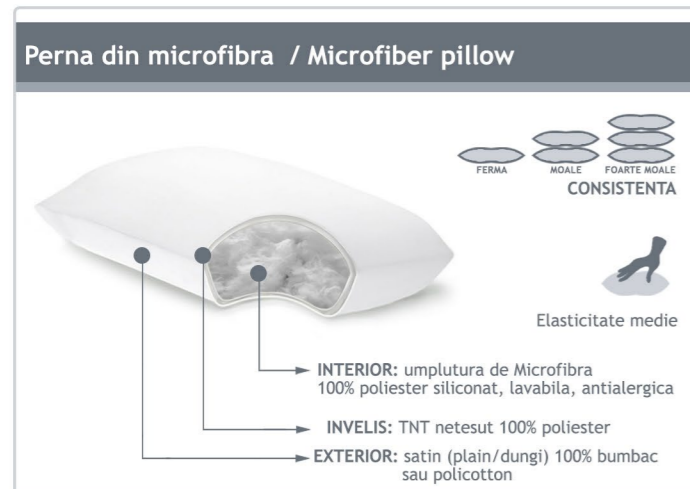

AVANTAJE : Microfibră este o fibră polyester ușoară, lavabilă, anti-alergică și are grad mare de revenire la forma inițială, au husă din țesătură Satin de calitate și sunt ideale pentru folosință intensivă.

ADVANTAGES : Microfiber is a lightweight polyester fiber, washable, anti-allergic and very elastic maintaining its original shape, the case made of fine Satin. Is ideal for intensive use.

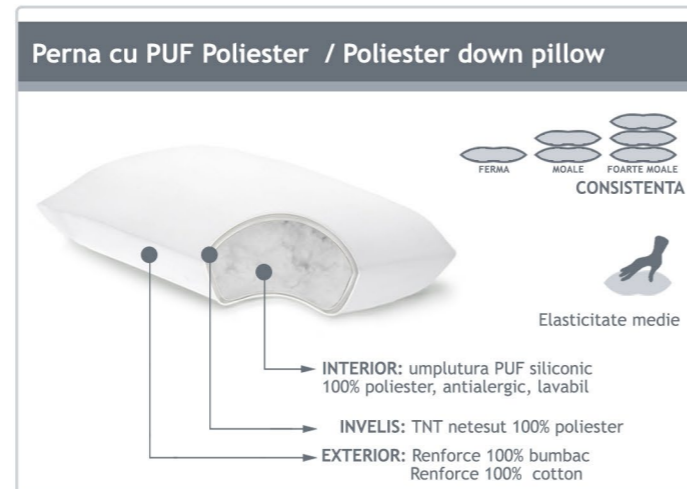

AVANTAJE : Perna cu umplutura PUF polyester siliconic este cea mai economică variantă. Husă confecționată din țesătură 100% bumbac Renforce de calitate asigură permeabilitate și confort.

ADVANTAGES : The Pillows with silicone polyester fiber filling is the most economical option. The cover 100% cotton fabric made with quality RENFORCE provide good permeability and comfort.

PILOTE MATLASATE / QUILTED DUVETS

Primavara - Vara / Spring - Summer

Umplutura: panouri vata Finessa 100% poliester / Filling: Polyester 100% Finessa



PILOTA MATLASATA CU PANOURI DE VATA FINESSA SI TESATURA RENFORCE

Pilotele matlasate Dormisete pentru primavara sunt fabricate cu panouri de vata Finessa 100% poliester antialergic, siliconat cu greutate de 200gr./mp și țesătura Renforce din bumbac 100%, sanforizat. Fiecare panou de vata fiind matlasat cu țesătura, pe toată suprafața pilotei, asigură stabilitatea la spălare și la folosire.

AVANTAJE : Aceste pilote sunt ușoare și confortabile, lavabile și anti-alergice, înlocuind cu succes vechile pleduri de lână sau poliester. Sunt pufoase, anti-alergice și lavabile. Țesătura 100% bumbac de calitate asigură circulația aerului în timpul somnului, permițând corpului să respire.

RENFORCE QUILTED DUVET WITH FINESSA WADDING POLYESTER 100%

Dormisete Spring duvets are made with 100% polyester Finessa wadding panels, is anti-allergic, weight of 200gr. / Sqm and 100% cotton fabric RENFORCE, sanforised, soft finish.

ADVANTAGES : These duvets are lightweight, comfortable and washable, successfully replacing old quilted heavy plaids in wool. Being fluffy, anti-allergic and washable, with 100% cotton fabric, ensure air circulation allowing the body to breathe during sleep.



Exclusiv la
Dormisete

Fabricat în
România

MOSTRA
GRATUITA

3
ANI
GARANTIE

CONFIDENCE
IN TEXTILES
Tested for harmful substances
according to Oeko-Tex® Standard 100
02.T.2249
Hohenstein

Tesătura 100% bumbac asigură circulația aerului! / Being with 100% cotton fabric, ensure air circulation!

PILOTE MATLASATE / QUILTED DUVETS

Primavara - Vara / Spring - Summer

Umplutura: panouri vata Finessa 100% poliester / Filling: Polyester 100% Finessa

CAMERA/ROOM



PILOTA MATLASATA CU PANOURI DE VATA FINESSA SI TESATURA CREPE

Pilotele matlasate Dormisete pentru primavara sunt fabricate cu panouri de vata Finessa 100% poliester antialergic, siliconat cu greutate de 200gr./mp si tesatura Crepe din bumbac 100%, ce nu necesita calcare. Fiecare panou de vata fiind matlasat cu tesatura, pe toata suprafata pilotei, asigura stabilitatea produsului atat la spalare cat si la folosinta indelungata.

AVANTAJE : Aceste pilote sunt usoare si confortabile, lavabile si antialergice, inlocuind cu succes vechile pleduri de lana sau poliester. Este pufoasă, hipoalergenică și lavabilă.

SEERSUCKER QUILTED DUVET WITH FINESSA WADDING POLYESTER 100%

Dormisete Spring duvets are made with 100% polyester Finessa wadding pannels, is antiallergic, weight of 200gr. / Sqm and 100% cotton fabric Seersucker, sanforised, soft finish.

ADVANTAGES : These duvets are lightweight, comfortable and washable, successfully replacing old quilted heavy plaids in wool. Being fluffy, antiallergic with 100% cotton fabric, ensure air circulation allowing the body to breathe during sleep, no ironing due to Seersucker fabric.



Exclusiv la
Dormiseto®



MOSTRA
GRATUITA

3
ANI
GARANTIE



PILOTE MATLASATE / QUILTED DUVETS

Toamna- iarna / Fall-Winter

Umplutura: panouri vata Finessa 100% poliester / Filling: Polyester 100% Finessa

CAMERA/ROOM



PILOTA MATLASATA CU PANOURI DE VATA FINESSA

Pilotele matlasate Dormisete pentru toamna iarna sunt fabricate cu panouri de vata Finessa 100% poliester antialergic, siliconat cu greutate de 400gr./mp si tesatura Renforce din bumbac 100%, sanforizat. Fiecare panou de vata fiind matlasat cu tesatura, pe toata suprafata pilotei, asigura stabilitatea produsului atat la spalare cat si la folosinta indelungata.

AVANTAJE : Aceste pilote sunt usoare si confortabile, calduroase, lavabile si antialergice, inlocuind cu succes vechile plapumi grele de lana sau poliester. Sunt pufoase, antialergice și lavabile. Tesatura 100% bumbac de calitate asigura circulatia aerului in timpul somnului, permitand corpului sa respire.

QUILTED DUVET WITH FINESSA WADDING POLYESTER 100%

Dormisete Fall Winter duvets are made with 100% polyester Finessa wadding pannels, is antiallergic, weight of 400gr. / Sqm and 100% cotton fabric RENFORCE, sanforised, soft finish.

ADVANTAGES : These duvets are lightweight, comfortable, warm and washable, successfully replacing old quilted heavy plaids in wool. Being fluffy, antiallergic and washable with 100% cotton fabric, ensure air circulation allowing the body to breathe and keep the optimal body temperature during sleep.



Exclusiv la
Dormiseto®



MOSTRA
GRATUITA

3
ANI
GARANTIE



Pilota din tesatura Crepe din bumbac 100%. / 100% cotton Seersucker quilted duvet.

Tesatura Renforce din bumbac 100%, sanforizat. / 100% cotton fabric RENFORCE, sanforised.

PILOTE MATLASATE / QUILTED DUVETS

Toamna-iarna / Fall-Winter

Umplutura: panouri vata Finessa 100% poliester / Filling: Polyester 100% Finessa

CAMERA/ROOM



PILOTA MATLASATA CU PANOURI DE VATA FINESSA

Pilotele matlasate Dormisete pentru toamna iarna sunt fabricate cu panouri de vata Finessa 100% poliester antialergic, siliconat cu greutate de 400gr./mp si tesatura Crepe din bumbac 100%, sanforizat. Fiecare panou de vata fiind matlasat cu tesatura, pe toata suprafata pilotei, asigura stabilitatea produsului atat la spalare cat si la folosinta indelungata.

AVANTAJE : Aceste pilote sunt usoare si confortabile, calduroase, lavabile si antialergice, inlocuind cu succes vechile plapumi grele de lana sau poliester. Sunt pufoase, antialergice și lavabile. Tesatura 100% bumbac de calitate asigura circulatia aerului in timpul somnului, permitand corpului sa respire, nu necesita calcare.

QUILTED DUVET POLYESTER 100%

Dormisete Fall Winter duvets are made with 100% polyester Finessa wadding pannels, is antiallergic, weight of 400gr. / Sqm and 100% cotton fabric SEERSUCKER, sanforised, soft finish.

ADVANTAGES : These duvets are lightweight, comfortable, warm, washable and no ironing, successfully replacing old quilted heavy plaids in wool. Being fluffy, antiallergic and washable with 100% cotton fabric, ensure air circulation allowing the body to breathe and keep the optimal body temperature during sleep.



Exclusiv la
Dormisete®



MOSTRA
GRATUITA

3
ANI
GARANTIE



PILOTE MATLASATE / QUILTED DUVETS

4 anotimpuri / 4 seasons

Umplutura: panouri vata Finessa 100% poliester / Filling: Polyester 100% Finessa

CAMERA/ROOM



PILOTA MATLASATA CU PANOURI DE VATA FINESSA

Acest set de pilote este format din doua pilote pufoase, usoare si confortabile, una pentru primavara-vara cu greutate de 200gr./mp si una pentru toamna-iarna cu greutate de 400gr./mp care, prin capsare, formeaza o pilota cu consistenta generoasa ce asigura confortul termic chiar si in perioadele geroase ale iernii.

AVANTAJE : Interiorul este format din panouri de vata Finessa 100% poliester antialergic, siliconat iar fetele sunt din tesatura de bumbac 100% Renforce. Pilota matlasata 4 anotimpuri cu tesatura Renforce este solutia optima pentru intregul an.

QUILTED DUVET WITH FINESSA WADDING POLYESTER 100%

This set of duvet consists of two fluffy duvets, lightweight and comfortable one for spring-summer weight of 200gr. / Sqm and one for autumn-winter weight of 400gr. / Sqm, with white plastic quality caps, forming a duvet with generous consistency and ensuring the thermal comfort even during the coldest winter.

ADVANTAGES : The filling consists of wadding panels Finessa in 100% polyester and 100% cotton fabric RENFORCE, sanforised. Washable and antiallergic, these duvets are successfully replacing the old heavy wool or polyester duvets. They are fluffy, warm and cozy, offering the best solution for the entire year.



Exclusiv la
Dormisete®



MOSTRA
GRATUITA

3
ANI
GARANTIE



Pilotele sunt pufoase, antialergice și lavabile. / These duvets are lightweight, comfortable, warm, washable.

Prin capsare, formeaza o pilota cu consistenta generoasa./ By quality caps a worm and fluffy duvet

PILOTE MATLASATE / QUILTED DUVETS

4 anotimpuri / 4 seasons

Umplutura: panouri vata Finessa 100% poliester / Filling: Polyester 100% Finessa

CAMERA/ROOM



PILOTA MATLASATA CU PANOURI DE VATA FINESSA CU TESATURA CREPE

Formate din doua pilote pufoase, usoare si confortabile, una pentru primavara cu greutate de 200gr./mp si una pentru toamna-iarna cu greutate de 400gr./mp care, prin capsare, aceste pilote formeaza o pilota cu consistenta generoasa ce asigura confortul termic chiar si in perioadele geroase ale iernii. Tesatura Crepe alb vaporoz si naturala 100% bumbac ii ofera un aspect deosebit.

AVANTAJE : Interiorul este format din panouri de vata Finessa 100% poliester antialergic, siliconat iar fetele sunt din tesatura de bumbac 100% Crepe ce nu necesita calcare. Lavabile si antialergice, inlocuind cu succes vechile plapumi grele de lana sau poliester, acestea sunt pufoase si ofera solutia optima pentru intregul an .

QUILTED DUVET WITH FINESSA WADDING POLYESTER 100% SEERSUCKER

This set of duvet consists of two fluffy duvets, lightweight and comfortable one for spring of 200g. / Sqm filling and one for autumn-winter weight of 400g. / Sqm filling , with white plastic quality caps, forming a duvet with generous consistency and ensuring the thermal comfort even during the coldest winter.

ADVANTAGES : The filling consists of wadding panels Finessa in 100% polyester and 100% cotton fabric Seersucker no ironing. Washable and antiallergic, these duvets are successfully replacing the old heavy wool or polyester duvets. They are fluffy, warm and cozy, offering the best solution for the entire year.



Exclusiv la
Dormiseto®

Fabricat in
România

MOSTRA
GRATUITA

3
ANI
GARANTIE

CONFIDENCE
IN TEXTILES
Tested for harmful substances
according to Oeko-Tex® Standard 100
02.T.2249
Hohenstein

Asigura confortul termic in perioadele geroase ale iernii. / Provide thermal comfort even during the cold winter.

Detalii tehnice / Technic details

Tipuri de pilote matlasate / Quilted duvets types

CAMERA/ROOM

Pilota matlasata 4 anotimpuri / Quilted 4 seasons duvet

Umplutura: panouri de vata Finessa
100% poliester antialergic, siliconat,
200gr.+400gr.=600 gr./mp.
Filing: Finessa wadding Polyester 100%



Sistem de prindere cu capse albe
Quality caps fastening system

Tesatura poate fi neteda sau creponata 100% bumbac
Plain or seersucker fabric 100% cotton

AVANTAJE :

Confectionate din tesatura 100% bumbac Renforce sanforizat si cu umplutura panouri vata polyester Finessa moale, usoara, calduroasa si antialergica 200gr/mp pentru pilotele de primavara si 400gr/mp pentru cele de toamna/iarna, sunt prevazute cu capse de calitate pentru imbinare formand o pilota generoasa de 600gr./mp pentru cele mai friguroase ierni.

ADVANTAGES :

Made of fabric 100% cotton Ranforce sanforised and filling of polyester panels Finessa soft, fluffy, warm and antiallergic , 200g / sqm for spring duvet and 400gr / sqm for fall / winter duvet, provided with white plastic quality staples to combine those 2 duvets in a warm duvet 600gr. / sqm suitable for the coldest winters.

PILOTA- Descriere tehnica / DUVET- Technical description

Straturile componente ale pilotei Dormiseto®
Dormiseto® Duvet layered description

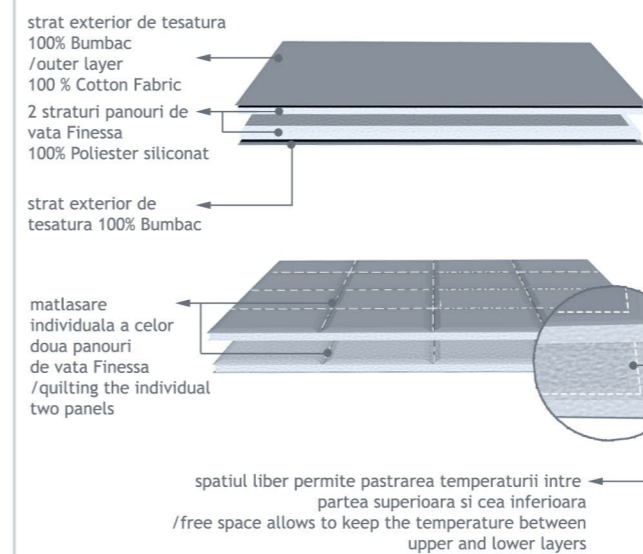

strat exterior de tesatura
100% Bumbac
/outer layer
100 % Cotton Fabric

2 straturi panouri de
vata Finessa
100% Poliester siliconat

strat exterior de
tesatura 100% Bumbac

matlasare
individuala a celor
doua panouri
de vata Finessa
/quilting the individual
two panels

spatiu liber permite pastrarea temperaturii intre
partea superioara si cea inferioara
/free space allows to keep the temperature between
upper and lower layers

AVANTAJE :

Confectionate din tesatura 100% bumbac Renforce sanforizat si cu umplutura panouri vata polyester Finessa moale, usoara, calduroasa si antialergica 200gr/mp pentru pilotele de primavara sau 400gr/mp pentru cele de toamna/iarna, sunt rezistente iar umplutura este stabila fiind matlasata pe ambele parti

ADVANTAGES :

Made of fabric 100% cotton Ranforce sanforised and filling of polyester panels Finessa soft, fluffy, warm and antiallergic , 200g / sqm for a spring duvet and 400gr / sqm for fall / winter the duvet are washable, resistant and with stable filling due to quilting on both sides.

Pilote usoare si confortabile pentru somn sanatos/ Fluffy, antiallergic and comfortable duvets, for healthy sleep

PROTECTIE SALTEA / MATTRESS PROTECTION

Husa protectie matlasata / Quilted mattress protection

Umplutura: panouri vata 100% poliester / Filling: Polyester 100% pannels

CAMERA/ROOM



■ PROTECTII PENTRU SALTEA MATLASATE

Husa de protectie matlasata pentru saltea este confectionata din tesatura Renforce 100% bumbac alb, cu umplutura din panouri de vata compacta 100% poliester, 140gr./mp, este antialergica, confortabila si lavabila.

AVANTAJE : Husa matlasata pentru protejarea saltelei este prevazuta cu banda elastica la cele 4 colturi pentru o fixare usoara de saltea si are atat rol de protectie a suprafetei saltelei cat si de sporire a confortului in timpul somnului. Acest produs poate fi confectionat la orice dimensiuni solicitate de client.

■ QUILTED MATTRESS PROTECTION

The quilted mattress protection is made of 100% cotton fabric RENFORCE white and compact wadding panels in 100% polyester, 140gr.g / Sqm, it is anti allergic, comfortable and washable.

ADVANTAGES : The quilted mattress protection is equipped with quality elastic band at the 4 corners for easy fitting on the mattress. It is protecting the mattress surface as well increase the comfort during sleep. This product can be made in any size requested by customer.



Exclusiv la
Domisete®

Fabricat în
România

MOSTRA
GRATUITA

3 ANI
GARANTIE

CONFIDENCE
IN TEXTILES
Tested for harmful substances
according to Oeko-Tex® Standard 100
02.T.2249
Hohenstein

Sporeste confortul in timpul somnului. / Improves comfort during sleep.

PROTECTIE SALTEA / MATTRESS PROTECTION

Husă protectie Tricot matlasat / Cotton Knit Mattress protection

Tricot peliculizat 100% bumbac / 100% Cotton Knit-waterproof

CAMERĂ/ROOM



■ PROTECTII PENTRU SALTEA FAGURE IMPERMEABIL

Protectia matlasata impermeabila este confectionata din tesatura Tricot din bumbac 100%, foarte rezistentă în timp si antialergică. Dosul tesaturii este peliculizat cu un strat de poliuretan asigurând o protectie impermeabila pentru saltea, model TOP asigurând protejarea suprafetei superioare a saltelei.

AVANTAJE : Pentru manevrare facila, aceasta husa de protectie este prevazuta cu banda elastica la cele 4 colturi asigurand o fixare precisa de saltea. Tesatura se preteaza la folosire intensiva atat in industria hoteliera cat si pentru spitale si unitati sociale de ingrijire.

■ WATERPROOF FAGURE MATTRESS PROTECTION

Protection waterproof quilted knit fabric is made from 100% cotton, very resistant in time and antiallergic. Wrong side of the fabric is Coated with a layer of polyurethane providing a waterproof mattress protection, providing protection model TOP upper surface of the mattress of the mattress.

ADVANTAGES : For as easy maintenance, this protective cover is fitted with elastic band the 4 corners to fit precise mattress. The fabric is suitable for intensive use both the hotel industry and for hospitals and social care units.



Exclusiv la
Domisete®

Fabricat în
România

MOSTRA
GRATUITA

3 ANI
GARANTIE

CONFIDENCE
IN TEXTILES
Tested for harmful substances
according to Oeko-Tex® Standard 100
02.T.2249
Hohenstein

Tesatura asigură aerisirea, lăsând pielea să respire. / Ensure ventilation fabric, leaving skin breathe.

PROTECTIE SALTEA / MATTRESS PROTECTION

Husa protectie Flanel / Flannel mattress protection

Flanel peliculizat 100% bumbac / 100% Cotton Flannel-waterproof

CAMERA/ROOM



■ PROTECTII PENTRU SALTEA FLANEL IMPERMEABIL

Husa impermeabila Flanel este confectionata din tesatura Flanel peliculizat 100% bumbac pe o parte iar pe cealalta cu pelicula de polyurethane impermeabil, antialergic, este model TOP asigurand protejarea suprafetei superioare a salteii.

AVANTAJE : Husa impermeabila din Flanel pentru protejarea salteii este prevazuta cu banda elastica la cele 4 colturi pentru o fixare precisa de saltea. Tesatura se preteaza la folosire intensiva atat in industria hoteliera cat si pentru spitale si unitati sociale de ingrijire.

■ WATERPROOF FLANNEL MATTRESS PROTECTION

Flannel waterproof mattress protector is made of 100% cotton fabric Flannel on one side and on the other with polyurethane film waterproof, hypoallergenic, ensuring protection of the superior surface of the mattress.

ADVANTAGES : The Flannel waterproof protection is equipped with quality elastic band at the 4 corners for perfect fit on the mattress. This product is suitable for intensive use both in the hotel industry and for hospital and social care.



Exclusiv la
Dormiseto®



MOSTRA
GRATUITA

3
ANI
GARANTIE



PROTECTIE SALTEA / MATTRESS PROTECTION

Husa protectie Frottier / Frottier mattress protection

Frottier 100% bumbac-impermeabilizat / 100% Cotton Terry-waterproof

CAMERA/ROOM



■ PROTECTII PENTRU SALTEA FROTTIER IMPERMEABIL

Husa impermeabila pentru saltea Frottier este confectionata din tesatura Frottier 100% bumbac cu dos impermeabilizat cu pelicula de poliuretan, protejeaza salteaua impotriva murdaririi, a incontinentei.

AVANTAJE : Tesatura se preteaza la folosire intensiva atat in industria hoteliera cat si pentru spitale si unitati sociale de ingrijire, se poate spala la temperaturi ridicate de 90°C.

■ WATERPROOF TERRY MATTRESS PROTECTION

The waterproof Terry mattress protector is made of 100% cotton Terry fabric one side and the other side is waterproof polyurethane film . It protects the mattress against dirt, incontinence.

ADVANTAGES : The fabric is 100% cotton , breathable. Being very resistant it is suitable for intensive use in the hotel industry and for hospital and social care units . It and can be washed at high temperatures of 90 ° C.



Exclusiv la
Dormiseto®



MOSTRA
GRATUITA

3
ANI
GARANTIE



Tesatura se preteaza la folosire intensiva ./ This product is suitable for intensive use.

Protejeaza salteaua impotriva murdaririi, a incontinentei./ It protects the mattress against dirt, incontinence.

TRAVERSE DE PAT / BED RUNNERS

Traverse reversibile pentru pat hotel, confectionate cu fata dubla din tesaturi tip Chenille imprimate si uni color asortate. Compozitia tesaturii este 100% poliester (PES), masa 320gr/mp +/- 3%, antipilling, rezistenta la folosire intensiva, nu se decoloreaza si nu se scamoseaza. Modelul Nihon reprezinta un desen pictural ce imita tusele de pensula, in nuante bej-verzui cu accente verde petrol si albastru inchis. Acest produs poate fi coordonat cu perne decorative si draperie asortate.

AVANTAJE : Este rezistentă la folosire intensivă, fiind soluția ideală pentru dotarea hotelurilor cu trafic intens, pensiunilor sau moteluri. Beneficiază de avantajul tratamentului antipilling ce asigura rezistenta la scamosare. Produs versatil, putand fi folosit pe ambele fete, combinandu-se cu perne decorative.

The bed runners are made of decorative Chenille fabrics printed with various textured effects, 100% polyester fabric composition, weight 320 gr/sqm +/- 3%, with antipilling. Can be combined with cushions. These fabrics can be well used to manufacture curtains or upholstery, thus completing the entire decorative ensemble of the room.

All fabrics are available in a wide range of colors, many combinations can be made with plain and printed fabrics, creating a particular aesthetic effect.

ADVANTAGES : The bed runners are reversible, with double face can be used on both sides. The cushions are provided with antiallergic filling and zipper for ease of maintenance. The fabrics are resistant to intensive use, do not fade or pilling.

MODELE DE TESATURI / FABRICS DESIGNS :

RALLYE SUMMER



NOU !

RECOMANDAT
HOTELURILOR
DE 4* SI 5*



TRAVERSE DE PAT / BED RUNNERS

NIHON 6



NOU !

RECOMANDAT
HOTELURILOR
DE 4* SI 5*

RALLYE COLD



NOU !

RECOMANDAT
HOTELURILOR
DE 4* SI 5*



CAMERA/ROOM

CAMERA/ROOM

TRAVERSE DE PAT / BED RUNNERS

RALLYE COLD 75



RALLYE COLD 24

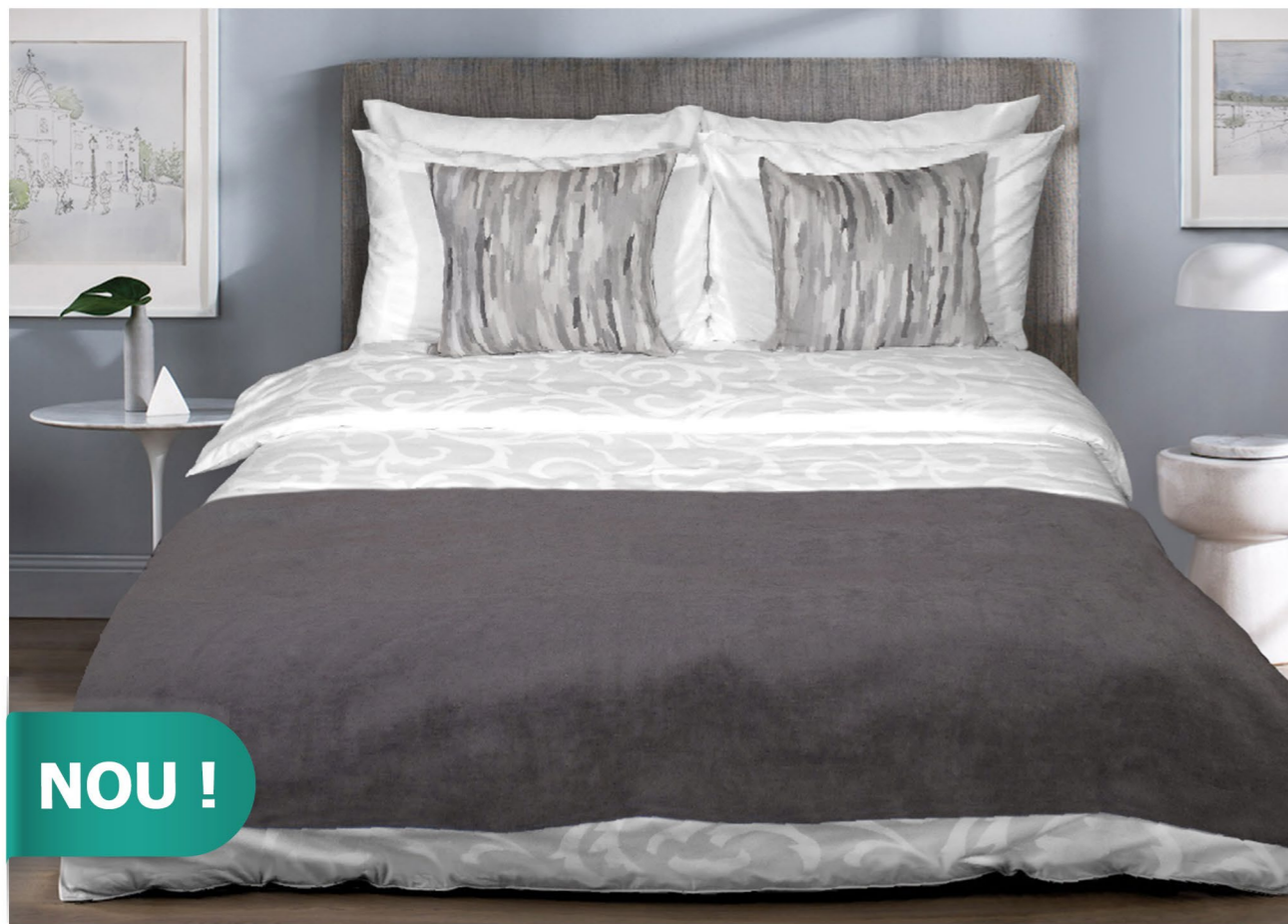

TRAVERSE DE PAT / BED RUNNERS

NIHON 4



TRAVERSE DE PAT / BED RUNNERS

NIHON 2



TRAVERSE DE PAT / BED RUNNERS

RALLYE LIGHT 12



RALLYE LIGHT 33



Se confecționează la orice dimensiuni solicitate de client. / Is manufactured in any size required by the customer .

Se confecționează la orice dimensiuni solicitate de client. / Is manufactured in any size required by the customer .

TRVERSE DE PAT / BED RUNNERS

Traversele pentru pat sunt confectionate din tesături decorative imprimate cu diverse efecte texturate, din țesături Jaquard sau tesaturi uni, compozitie tesătură 100% poliester, masa 290 gr/mp, antipilling. Pot fi combinate cu perne decorative imprimate, Jacquard sau unicolor. Aceste tesaturi pot fi folosite si la confectionarea draperiilor sau tapitare mobilier completând astfel întreg ansamblul decorativ al camerei.

Toate tesaturile sunt disponibile intr-o gamă cromatică variată și pot fi realizate combinații de tesături imprimate cu uni sau Jacquard cu uni, creând un efect estetic deosebit.

AVANTAJE : Traversele sunt reversibile, având fata dublă se poate folosi pe ambele părți. Pernele decorative sunt prevăzute burduf antialergic și husă cu fermoar pentru ușurință în întreținere. Tesăturile sunt rezistente la folosire intensivă, nu se decolorează și nu se scamează.

The bed runners are made of decorative fabrics printed with various textured effects, Jacquard or uni, 100% polyester fabric composition, weight 290 gr/sqm, with antipilling. Can be combined with cushions. These fabrics can be well used to manufacture curtains or upholstery, thus completing the entire decorative ensemble of the room.

All fabrics are available in a wide range of colors, many combinations can be made with plain and printed fabrics, Jacquard and Plain fabrics, creating a particular aesthetic effect.

ADVANTAGES : The bed runners are reversible, with double face can be used on both sides. The cushions are provided with antiallergic filling and zipper for ease of maintenance. The fabrics are resistant to intensive use, do not fade or pilling.

MODELE DE TESATURI / FABRICS DESIGNS :

DORSET



TRVERSE DE PAT / BED RUNNERS

PARIS, LIDO



LIDO

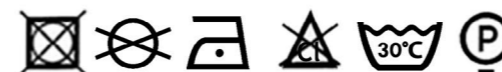

TRVERSE DE PAT / BED RUNNERS

BUDAPEST



CAMERĂ/ROOM

TRVERSE DE PAT / BED RUNNERS

KENDAL

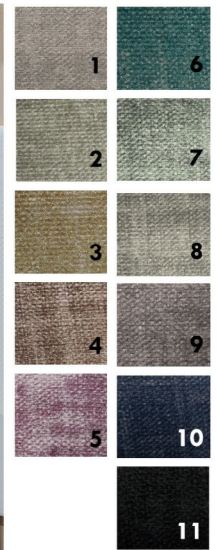

CAMERĂ/ROOM

JEAN

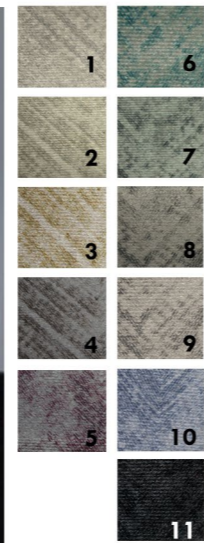

TOBAGO

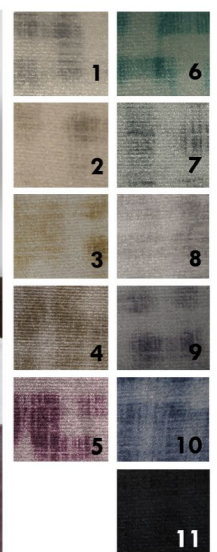

Se confecționează la orice dimensiuni solicitate de client. / Is manufactured in any size required by the customer.

Se confecționează la orice dimensiuni solicitate de client. / Is manufactured in any size required by the customer.

TEXTILE DECOR / TEXTILES DECOR

■ PERDELE ȘI DRAPERII

În crearea unui spațiu armonios și cu personalitate, perdelele și draperiile completează efectul cromatic. Indiferent de stilul interiorului (clasic, modern, minimalist, baroc, etc) țesăturile alese trebuie să aibă



atât rol practic (de umbrire și/sau obscurizare, izolare termică și fonică), dar și rol estetic și delimitare a spațiului. Gama de țesături este vastă (catifea, tafta, jaquard, blackout, batist, bumbac, mătase naturală, poliester, acril, voal, organza, etc) iar aceste materiale pot fi tratate special (ignifugare, teflonare, tratamente pentru antifonare, antistatice sau antimurdărire cât și antibacteriene, evident cu o mare diversitate de pattern-uri și culori cu lățimi cuprinse între 140 și 330 cm, ceea ce va permite specialiștilor noștri să creeze interioare personalizate, cu stil și rafinament, în funcție de destinația clădirii și dorințele beneficiarului.

■ SHEERS AND CURTAINS

In creating a harmonious and intimate space the curtains and sheers complete the chromatic effect. Regardless of the interior style (classic, modern, minimalist, baroque, etc.), the chosen fabrics must have both a practical (shading and/or obscuration, thermal and acoustic insulation), as well as an aesthetic role and space delimitation. The range of fabrics is wide (velvet, taffeta, jaquard, blackout, handkerchief, cotton, natural silk, polyester, acrylic, voile, organza etc.), all these materials can be specially treated (fireproof, teflon, antistatic, as well as antibacterial) obviously with a wide variety of patterns and colors in widths from 140cm to 330 cm, that will allow our specialists to create personalized interiors with style and refinement, depending on the space destination and the client's requirements

■ SISTEME PRINDERE

Sistemele de prindere, chiar dacă reprezintă elemente cu caracter tehnic, sunt importante în decorarea ferestrelor. Alegerea acestora este dictată de forma ferestrelor și de modul în care pot fi montate. Gama sistemelor este vastă, cuprinzând șine și sisteme de stor (manuale sau electrice), galerii (de lemn, metal sau plastic) și panouri japoneze. Specialiștii noștri vă vor indica cele mai potrivite sisteme, în concordanță cu designul de interior și construcția clădirii (cazul spațiilor curbate, foarte înalte sau deschideri vitrate mari).

■ POLES AND TRACKS

Poles and tracks, even if technical, they are important elements in the windows decoration. The selection depend on the shape of the windows and the way they can be fitted. The range of systems is large, including metal, plastic and wood poles, track systems (manual or electrical) and Japanese panels. Our specialists will show you the most appropriate systems in accordance with the interior design and the building construction (especially if there are curved, very tall spaces or very large glazed openings).

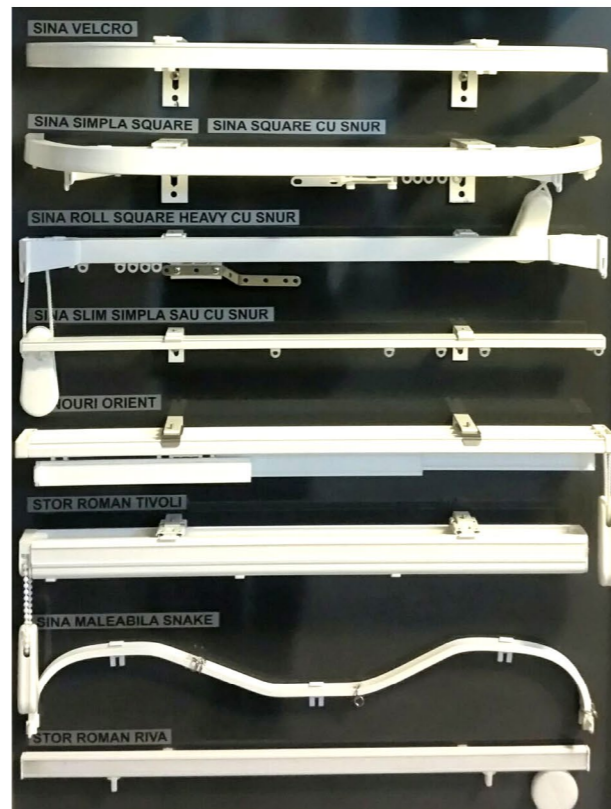

DECORAȚIUNI / ROOM DECORATIONS

■ CORPURI DE ILUMINAT

În amenajarea unui spațiu, fie cameră de hotel, hol, sală de așteptare sau sală restaurant, corpurile de iluminat joacă un rol foarte important, acestea asigurând atât iluminarea funcțională cât și decorativă, prin punerea în valoare a unor anumite elemente de decor din spațiul respectiv. În funcție de specificul spațiului care necesită proiect de iluminat, putem alege dintr-o gamă extinsă de corpuri de iluminat în stil clasic sau modern (candelabre, aplice, plafoniere, lustre, benzi led, spoturi pentru interior sau exterior), pe care o punem la dispoziție împreună cu serviciile noastre de consultanță.

■ LIGHTENING

Decorating an interior, either a hotel room, a lobby, a rest room or a ballroom, the lighting play a very important role, ensuring both functional and decorative lighting, by highlighting certain decoration objects. The specificity of the space requires a certain lighting design. So you can choose from a wide range of classical or modern designs (chandeliers, ceilings, indoor or outdoor spots) and we are always available with our professional services.



■ MOBILIER

Design original, minimalist sau clasic, cu funcționalitate perfectă, armonios îmbinate în soluțiile propuse de noi pentru mobilarea camerei de hotel, a spațiilor de odihnă și a sălilor de bar sau restaurant.

■ FURNITURE

Original design, minimalist or classic, with perfect functionality, harmoniously combined in the solutions proposed by us to furnish the hotel room, the rest areas and the bar or restaurant rooms.



PROSOAPE BAIE / BATH TOWEL

Colectia Royal / Royal Collection

Tesatura Jacquard 100% bumbac / Jacquard Terry 100% Cotton



Personalizare cu logo :
Customize with logo :

RECOMANDAT
HOTELURILOR
DE 4* SI 5*

PROSOAPELE DE BAIE JAQUARD BORDURA MOSAIC

Prosoapele de baie Jacquard model Mosaic Border sunt moi si placute la atingere cu un grad mare de absorbtie conferit de consistenta generoasa de 600gr./mp a frottierului 100% bumbac, cu fir dublu rasucit. Au un model discret si elegant cu patratele ce se preteaza oricarui stil decorativ.

AVANTAJE : Datorita cusaturilor duble si rezistente, acest produs are o rezistenta sporita la folosire intensiva si poate fi folosit la dotarea bailor hotelurilor de 4-5*.

MOSAIC BORDER JACQUARD BATH TOWEL

The Jacquard Mosaic Border Terry towels are soft and very fluffy, with a high absorbancy provided by the overall consistency of 600gr. / sqm of the 100% cotton double-twisted yarn Terry. It has a discreet and elegant squares model which is suitable for any decorative style.

ADVANTAGES : Due to double stitching and the Terry consistency, this product is high resistant to intensive use and can be selected successfully in equipping the bathrooms of 4-5 * hotels.



Exclusiv la
Domiseto®



Fabricat in
România



Tested for harmful substances
according to Oeko-Tex® Standard 100
02.T.2249
Hohenstein

HALATE DE BAIE / BATHROBES

Colectia Royal / Royal Collection

Velour 100% bumbac / Velour 100% Cotton



RECOMANDAT
HOTELURILOR
DE 4* SI 5*

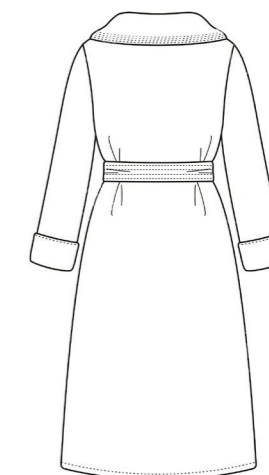
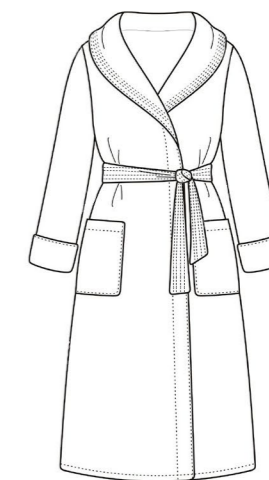

HALATE DE BAIE VELOUR

Rasfatati-va oaspetii cu halatele de baie Velur, moi, pufoase, cu o consistenta generoasa de 450gr./mp, cu suprafata moale si fina ca de catifea iar interiorul Frottier moale si absorbant. Cu croiala ampla si eleganta cu guler sal, buzunare si cordon, acest halat va fi cu siguranta apreciat de cei mai exigenti clienti.

AVANTAJE : Datorita cusaturilor durabile si a tesaturii de calitate, acest produs are o rezistenta sporita la folosire intensiva si poate fi folosit cu succes la dotarea bailor hotelurilor de 4-5*. Masuri disponibile L si XL.

VELOUR BATHROBES

Indulge your guests with velour bathrobes, soft, fluffy, with an overall consistency of 450gr./Sqm, soft and smooth as velvet on front side and soft and absorbent on inside due to the Terry fabric. Ample and elegant design with shawl collar, pockets and belt, this bath robe will surely be appreciated by the most demanding clients.

ADVANTAGES : Due durable stitching and fabric quality, this product has a high resistance to intensive use and can be used successfully in equipping the bathrooms of 4-5 * hotels. Available sizes L and XL.



Exclusiv la
Domiseto®



Fabricat in
România



Tested for harmful substances
according to Oeko-Tex® Standard 100
02.T.2249
Hohenstein

COVORAS BAIE / BATH MAT

Colectia Royal / Royal Collection

Tesatura Jacquard 100% bumbac / Jacquard Terry 100% Cotton



RECOMANDAT
HOTELURILOR
DE 4* SI 5*

Personalizare cu logo :
Customize with logo :

■ COVORAS DE BAIE JAQUARD CU BORDURA MOSAIC

Acest covoras de baie alb, Jaquard model Mosaic, este confectionat din tesatura Frottier 100% bumbac, fir dublu rasucit, cu o greutate de 800gr./mp, deosebit de moale si absorbant si are un aspect simplu si elegant ce se preteaza oricarui stil decorativ.

AVANTAJE : Datorita cusaturilor duble si rezistente, acest produs are o rezistenta sporita la folosire intensiva si poate fi folosit la dotarea bailor hotelurilor de 4-5*.

■ MOSAIC BORDER JACQUARD BATH MAT

This white bathmat with Jacquard pattern Mosaic is made of the 100% cotton Terry double twisted yarn, very tick with a weight of 800gr. / Sqm, very soft and absorbent, simple and elegant design suitable for any decorative style .

ADVANTAGES : Due to double and durable stitchings, this product has a high resistance to intensive use and can be used in equipping the bathrooms of 4-5 * hotels.



Exclusiv la
Domiseto®



MOSTRA
GRATUITA

3
ANI
GARANTIE



PAPUCI DE BAIE / BATH SLIPPERS

Colectia Royal / Royal Collection

Frottier 100% bumbac / Terry 100% Cotton



RECOMANDAT
HOTELURILOR
DE 4* SI 5*

Personalizare cu logo :
Customize with logo :

■ PAPUCI DE BAIE

Fabricati din tesatura Frottier 100% bumbac atat la exterior cat si la interior, papucii de baie Royal sunt ideali pentru dotarea bailor de hotel, centrelor SPA, sauna, piscine.

AVANTAJE : Comози si absorbanti, papucii de baie Royal sunt prevazuti cu talpa moale din burete. Pot fi personalizati prin brodate.

■ BATH SLIPPERS

Made of 100% cotton Terry fabric both outside and inside, the bath slippers Royal are ideal for equipment of hotel bathrooms, SPA centers, saunas, swimming pools.

ADVANTAGES : Comfortable and absorbent, the slippers Royal are provided with soft sponge soles. They can be customized by embroidery.



Exclusiv la
Domiseto®



MOSTRA
GRATUITA

3
ANI
GARANTIE



Frottier deosebit de moale si absorbant. / Terry very soft and absorbent .

Papuci pufosi pentru clienti pretentiosi! / Soft slippers for most demanding clients!

PROSOAPE BAIE / BATH TOWELS

Colectia Premium / Premium Collection

Tesatura Jacquard 100% bumbac / Jacquard Terry 100% Cotton

Personalizare cu logo :
Customize with logo :



RECOMANDAT
HOTELURILOR
DE 3* SI 4*

PROSOAPELE DE BAIE JAQUARD MODEL GREEK BORDER

Prosoapele de baie Jacquard model Greek Border sunt moi si placute la atingere cu un grad mare de absorbtie conferit de consistenta generoasa de 500gr./mp a frottierului 100% bumbac, cu fir dublu rasucit.

AVANTAJE : Datorita aspectului elegant si a cusaturilor duble si rezistente, acest produs are o rezistenta sporita la folosire intensiva si poate fi folosit la dotarea bailor hotelurilor de 3-4*.

GREEK BORDER JACQUARD BATH TOWELS

The Jacquard pattern Terry towels model Greek Border are soft and fluffy, with a high absorbancy provided by the overall consistency of 500 gr. / Sqm of the 100% cotton Terry in double-twisted yarn.

ADVANTAGES : Due to elegant design and durable double stitching, this product is very resistant to intensive use and can be successfully selected to equip the bathrooms in 3-4 * hotels .



Exclusiv la
Domiseto®



MOSTRA
GRATUITA

3
ANI
GARANTIE



HALATE DE BAIE / BATHROBES

Colectia Premium / Premium Collection

Frottier 100% bumbac / Terry 100% Cotton



RECOMANDAT
HOTELURILOR
DE 3* SI 4*

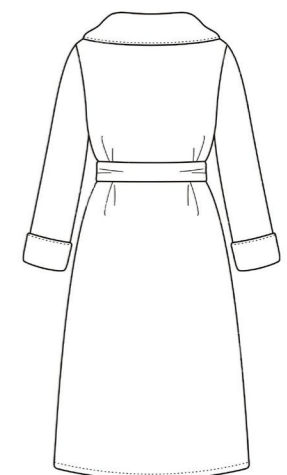
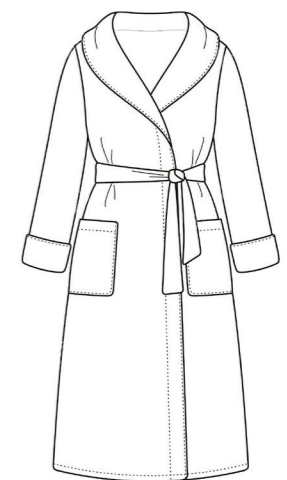

HALATE DE BAIE FROTTIER GULER SHAL

Halatul de baie cu guler shal este confectionat din Frottier 100% bumbac, greutate 420gr./mp, este prevazut cu buzunare si cordon. Marimile standard ale halatelor de baie sunt: L, XL, XXL.

AVANTAJE : Este pufos, absorbant si comod, fiind solutia optima pentru a va primi oaspetii la relaxare in centrul spa sau la piscina.

TERRY BATHROBES MODEL SHAWL

The bathrobe with shawl collar is made of 100% cotton Terry , weight 420gr. / Sqm, with pockets and belt. The standard sizes are: L, XL, XXL.

ADVANTAGES : Fluffy, absorbent and comfortable is the ideal solution to welcome the guests to relax in your rooms, spa or pool.



Exclusiv la
Domiseto®



MOSTRA
GRATUITA

3
ANI
GARANTIE



Aspect elegant si a cusaturi duble si rezistente. / Stylish appearance and double stitching and durable .

Solutia optima pentru relaxare in centrul spa sau la piscina./The optimal solution for relaxing in the spa or pool.

HALATE DE BAIE / BATHROBES

Colectia Basic / Basic Collection

Frottier 100% bumbac / Terry 100% Cotton

BAIE/BATHROOM



RECOMANDAT
HOTELURILOR
DE 3* SI 4*

■ HALATE DE BAIE FROTTIER MODEL KIMONO

Halatul de baie model kimono, confectionat din Frottier 100% bumbac, greutate 350gr./mp, are guler kimono, buzunare si cordon si este varianta economica pentru dotarea bailor si centrelor spa. Marimile standard ale halatelor de baie sunt: L, XL, XXL.

AVANTAJE : Fiind pufos, absorbant si comod, este solutia potrivita pentru asigurarea unui confort relaxant clientilor dvs.

■ TERY BATHROBES MODEL KIMONO

The bathrobe model kimono, made of 100% cotton Frottier, weight 350gr. / sqm, designed with kimono collar, pockets and belt, is the most economical solution for equipping hotel bathrooms and spa centers. The bathrobe standard sizes are: L, XL, XXL.

ADVANTAGES : Being fluffy, absorbent and comfortable, is the right solution for providing your guests a relaxed and cosy sitting



Exclusiv la
Domiseto®



Fabricat in
România



MOSTRA
GRATUITA



3 ANI
GARANTIE



CONFIDENCE
IN TEXTILES

Tested for harmful substances
according to Oeko-Tex® Standard 100
02.T.2249
Hohenstein

COVORAS BAIE / BATH MAT

Colectia Premium / Premium Collection

Tesatura Jacquard 100% bumbac / Jacquard Terry 100% Cotton

BAIE/BATHROOM



Personalizare cu logo :
Customize with logo :



RECOMANDAT
HOTELURILOR
DE 3* SI 4*

■ COVORAS DE BAIE JAQUARD CU BORDURA GRECEASCA

Acest covoras de baie alb model Jacquard Greek Border cu Talpi, este confectionat din tesatura Frottier 100% bumbac, fir dublu rasucit, cu o greutate de 750gr./mp, este moale, pufos si foarte absorbant, are un aspect decorativ.

AVANTAJE : Datorita aspectului elegant si cusaturilor duble si rezistente, acest produs are o rezistenta sporita la folosire intensiva si poate fi folosit cu succes la dotarea bailor hotelurilor de 3-4*.

■ GREEK BORDER JACQUARD BATH MAT

This white bath mat with Jacquard Greek Border and sole is made of 100% cotton Terry fabric, with double twisted yarn and a weight of 750gr. / Sqm. It is soft, fluffy, very absorbent and decorative.

ADVANTAGES : Due to elegant design and double stitching durable, this product has a high resistance to intensive use and can be used successfully in bathrooms of 3-4* hotels.



Exclusiv la
Domiseto®



Fabricat in
România



MOSTRA
GRATUITA



3 ANI
GARANTIE



CONFIDENCE
IN TEXTILES

Tested for harmful substances
according to Oeko-Tex® Standard 100
02.T.2249
Hohenstein

Modelul kimono este varianta economica./The kimono style is the economic version.

Frottier super absorbant, 100% bumbac de calitate. / Terry super absorbent, 100% quality cotton.

PAPUCI DE BAIE / BATH SLIPPERS

Colectia Premium / Premium Collection

Frottier 100% bumbac / Terry 100% Cotton

BAIE/BATHROOM



RECOMANDAT
HOTELURILOR
DE 3* SI 4*

■ PAPUCI DE BAIE FROTTIER

Fabricati din tesatura Frottier 100% bumbac atat la exterior cat si la interior, papucii de baie Premium sunt ideali pentru dotarea bailor de hotel, centrelor SPA, sauna, piscine.

AVANTAJE : Comozi si usori, papucii de baie Premium sunt prevazuti cu talpa PVC grosime 40 mm. Pot fi personalizati prin brodate.

■ TERRY BATH SLIPPERS

Made of 100% cotton Terry fabric both outside and inside, the bath slippers Premium are ideal for equipment of hotel bathrooms, SPA centers, saunas, swimming pools.

ADVANTAGES : Comfortable and absorbent, the slippers Premium are provided with soft sponge soles 40 mm. They can be customized by embroidery.

Exclusiv la
Dormiseto®



MOSTRA
GRATUITA

3
ANI
GARANTIE



PROSOAPE BAIE / BATH TOWELS

Colectia Basic / Basic Collection

Tesatura Plain 100% bumbac / Plain fabric 100% Cotton

BAIE/BATHROOM



RECOMANDAT PENSINIILOR,
UNITATILOR DE INGRIJIRE,
MOTELURI/HOTELURI DE 2*,3*

■ PROSOAPELE DE BAIE

Prosoapele de baie model Plain (simplu) sunt moi si placute la atingere cu un grad mare de absorbtie conferit de consistenta de 400gr./mp a frottierului 100% bumbac, cu fir dublu rasucit.

AVANTAJE : Datorita cusaturilor duble si rezistente, acest produs are o rezistenta sporita la folosire intensiva si poate fi folosit la dotarea bailor hotelurilor de 2-3*, pensiuni, moteluri, tabere. Acest produs este cea mai economica varianta de prosop.

■ BATH TOWELS

The Terry towels model Plain are soft and fluffy, very absorbant provided by the 100% cotton double twisted yarn and a mass of 400gr. / Sqm .

ADVANTAGES : Due to double seams very durable, this product is high resistant to intensive use and can be selected in equipping bathrooms of 2-3 * hotels, hostels, camps. This product is the most economic option for towels.



Exclusiv la
Dormiseto®



MOSTRA
GRATUITA

3
ANI
GARANTIE



Moi, usori si absorbanti. / Soft, light weight and absorbant.

Folosit la dotarea hotelurilor de 2-3*, pensiuni, moteluri, tabere. / Used equipping bathrooms 2-3 * hotels, hostels, camps.

HALATE DE BAIE / BATHROBES

Colectia Basic / Basic Collection

Pique 100% bumbac / Waffle 100% Cotton



RECOMANDAT PENSIUNILOR,
UNITATILOR DE INGRIJIRE,
MOTELURI/HOTELURI DE 2*,3*

■ HALATE DE BAIE PIQUE

Halatul de baie model kimono, confectionat din Pique 100% bumbac, greutate 260gr./mp, cu guler kimono, buzunare si cordon, este varianta economica pentru dotarea bailor si centrelor spa. Marimile standard ale halatelor de baie sunt: L, XL, XXL.

AVANTAJE : Fiind confectionat din tesatura 100% bumbac foarte absorbanta si comoda, este solutia potrivita pentru asigurarea unui confort relaxant clientilor dvs.

■ WAFFLE BATHROBES

The bathrobe Waffle, made of 100% cotton, weight 260gr./Sqm, with kimono collar, pockets and belt, is the economical solution for equipping hotel bathrooms and spa centers. The bathrobe standard sizes are: L, XL, XXL.

ADVANTAGES : Being made of 100% cotton fabric very absorbent and comfortable, it is the right solution for your clients to ensure a relaxing comfort.



Exclusiv la
Domiseto®



MOSTRA
GRATUITA

3
ANI
GARANTIE



COVORAS BAIE / BATH MAT

Colectia Basic / Basic Collection

Tesatura Plain 100% bumbac / Plain Terry 100% Cotton



RECOMANDAT PENSIUNILOR,
UNITATILOR DE INGRIJIRE,
MOTELURI/HOTELURI DE 2*,3*

■ COVORASE DE BAIE

Acest covoras de baie alb model Plain cu Talpi, este confectionat din tesatura Frottier 100% bumbac, fir dublu rasucit, cu o greutate de 700gr./mp, este moale, pufos si foarte absorbant, are un aspect decorativ.

AVANTAJE : Datorita aspectului elegant si cusaturilor duble si rezistente, acest produs are o rezistenta sporita la folosire intensiva si poate fi folosit cu succes la dotarea bailor hotelurilor de 2-3*, pensiunilor, motelurilor. Este cea mai economica varianta de covoras baie .

■ BATH MATS

This white Bath mat model Plain with sole is made of 100% cotton Terry fabric , double twisted yarn with a mass of 700gr. / Sqm, it is soft, fluffy and very absorbent, is decorative.

ADVANTAGES : Due to paractical design and double stitching durable, this product has a high resistance to intensive use and can be used successfully in bathrooms of 2-3 * hotels, motels, care units, guesthouses. It is the most economical option of bath mat.



Exclusiv la
Domiseto®



MOSTRA
GRATUITA

3
ANI
GARANTIE



Pique super absorbant, 100% bumbac de calitate! / Super absorbant Waffle 100% quality cotton!

Este moale, pufos si foarte absorbant. / It is soft, fluffy and very absorbent.

TEXTILE SPA / SPA TEXTILES

Colectia Royal & Premium / Royal & Premium Collection
Frottier 100% bumbac / Terry 100% Cotton

BAIE/BATHROOM

NOU !



RECOMANDAT
CENTRELOR SPA
DE 3* SI 5*

■ PROSOP JACQUARD MODEL MOSAIC BORDER COLOR PENTRU SAUNA & SPA

Prosoapele Jacquard, model Mosaic Border sunt moi si placute la atingere cu un grad mare de absorbtie conferit de Frottierul 100% bumbac fabricat cu fir dublu rasucit si cu masa de 600gr./mp a produsului. Dimensiunea generoasa 50x90 cm si 70x140cm asigura un confort optim.

AVANTAJE : Datorita cusaturilor duble si rezistente, acest produs are o rezistenta sporita la folosire intensiva si poate fi folosit la dotarea centrelor SPA, saunelor si piscinelor. Acest produs este vopsit cu coloranti ecologici, rezistenti la spalari repetate.

■ TERRY TOWELS MOSAIC BORDER UNI COLOR FOR SPA & SAUNA

The Jacquard Mosaic Border Terry towels are soft and very fluffy, with a high absorbancy provided by the overall consistency of 600gr. / sqm of the 100% cotton double-twisted yarn Terry. It has a discreet and elegant squares model which is suitable for any decorative style.

ADVANTAGES : Due to double seams for durability, this product is highly resistant to intensive use and can be used to equip SPA centers, saunas and swimming pools. This product is dyed with eco colorants, high color fastness.



Exclusiv la
Dormisete



MOSTRA
GRATUITA

3
ANI
GARANTIE



Detalii tehnice / Technic details

Tipuri de prosoape pentru baie / Bathroom towels types

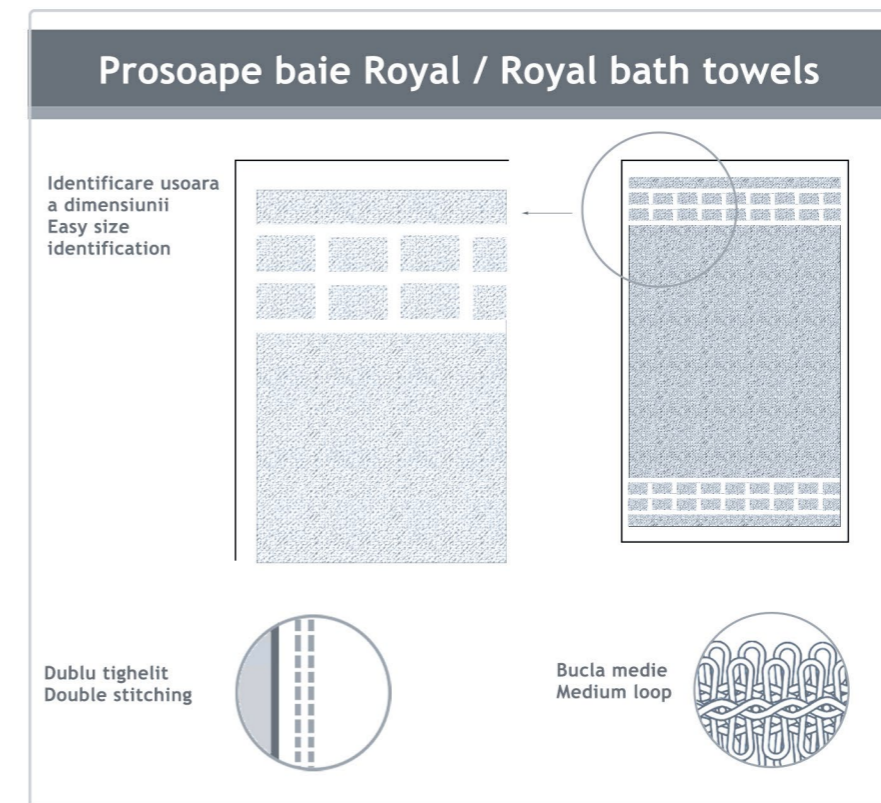

BAIE/BATHROOM

AVANTAJE : Prosoapele de baie Mosaic din colectia Royal, pe langa consistenta generoasa, moliciunea, gradul mare de absorbtie si executie ireprosabila a confectionii, sunt concepute astfel incat sa usureze munca menajerei atunci cand le selecteaza. Astfel, prosopul de maini este prevazut cu 2 randuri de patratele, cel de fata cu 3 randuri, cel de baie cu 4 randuri iar covorasul este prevazut cu chenar.

ADVANTAGES : The Terry towels design Mosaic from Royal collection, besides generous consistency, softness, highly absorbancy and high quality confection execution, are specially designed for easy selection by the housekeeper. The handling time is reduced because the hand towel is provided with 2 rows, the face towel with 3 rows, the bath towel with 4 rows and the bath mat with frame.

TEXTILE&COSMETICE SPA / SPA COSMETICS &TEXTILES

Frottier 100% bumbac / Terry 100% Cotton



Personalizare cu logo :
Customize with logo :

■ PROSOAPE SPA & SAUNA

Prosoapele de sauna si Spa model Plain (simplu) sunt moi si placute la atingere cu un grad mare de absorbtie conferit de Frottierul 100% bumbac fabricat cu fir dublu rasucit si cu masa de 400gr./mp a produsului. Pot fi fabricate in diverse culori.

AVANTAJE : Datorita cusaturilor duble si rezistente, acest produs are o rezistenta sporita la folosire intensiva si poate fi folosit la dotarea centrelor Spa. Acest produs are un raport optim calitate pret.

■ SPA & SAUNA TOWELS

The Terry towels model Plain are soft and fluffy, very absorbant provided by the 100% cotton double twisted yarn and a mass of 400gr. / Sqm . Ideal for Spa and sauna centers.

ADVANTAGES : Due to double seams very durable, this product is high resistant to intensive use and can be selected in equipping the Spa centers. This product is the most economic option for Spa towels.



Exclusiv la
Domiseto®



MOSTRA
GRATUITA

3
ANI
GARANTIE



Frottier super absorbant, 100% bumbac de calitate / 100% cotton Terry highly absorbant.

TEXTILE&COSMETICE SPA / SPA COSMETICS &TEXTILES

Frottier 100% bumbac si Policotton / Terry 100% Cotton and Policotton



■ PROSOAPE DE PLAJA & PISCINA

Prosoapele de plaja si piscina model Plain (simplu) colorate si imprimate digital sunt moi si placute la atingere cu un grad mare de absorbtie, compozitie Frottierul 100% bumbac sau bunbac cu poliester in diverse proportii, cu masa de 300-400gr./mp. Pot fi fabricate in diverse culori si imprimate la cerere cu logo-ul clientului.

AVANTAJE : Datorita posibilitatilor nelimitate de imprimare digitala, acest produs reprezinta un veritabil instrument de promovare a afacerii dvs. Poate fi folosit cu succes la dotarea hotelurilor cu piscina si plaja. Acest produs are un raport optim calitate pret.

■ BEACH & POOL TOWELS

The Terry towels model Plain are soft and fluffy, very absorbant provided by the 100% cotton double twisted yarn and a mass of 300- 400gr. / Sqm . Ideal for Spa and sauna centers.

ADVANTAGES : Due to double seams very durable, this product is high resistant to intensive use and can be selected in equipping the Spa centers. This product is the most economic option for Spa towels and is a very useful promotion item.



Exclusiv la
Domiseto®



MOSTRA
GRATUITA

3
ANI
GARANTIE



Prosoape personalizate, imprimate digital. / Towels personalized with digital printing .

TEXTILE&COSMETICE SPA / SPA COSMETICS &TEXTILES

Cosmetice naturale cu ape termale / Natural cosmetics with thermal water



■ COSMETICE PENTRU INGRIJIRE CORPORALA

Ischia, insula tineretii vesnice situata intr-o zona ce abunda de paduri de pin, plantatii de citrice si vita de vie si miraculoasele ape termale, sursa de sanatate si frumusetate. Apele termale din Ischia sunt alcaline, contin sulf, iod, clor, fier, potasiu si oligoelemente ale substantelor active. Combinatia perfecta dintre extractele naturii, apele termale si tehnologiile avansate a facut ca „ISCHIA LE TERME DELLA BELLEZZA” sa realizeze linia de produse cosmetice naturale pentru ingrijirea fetei si a corpului cunoscute in intreaga lume. Printre cele mai apreciate produse de ingrijire se numara: uleiurile de masaj, creme anticelulitice pe baza de namol, tratamente complete anticelulitice, creme de intretinere a pielii, tonice, impachetari fango.

Produse cosmetice si de ingrijire de inalta calitate pentru SPA cand frumusetatea izvoraste din natura

■ COSMETICS FOR BODY CARE

Ischia, the biggest island in the Gulf of Naples is well-known all over the world as The Island of Eternal Youth. This definition is based on its richness in pinewoods, citrus plantations and vineyards but primarily on its wonderful thermal water. For years Ischia Le Terme della Bellezza has produced natural cosmetics - the refined result of skilful combinations between Thermal Water and precious natural active principles such as Sweet Almond Oil, Karite Butter, Lemon and Orange Essential Oil, Butcher's Broom, Chestnut, Green Tea, Menthol, Ivy, Pot Marigold. Among the most appreciated care products include: massage oils, anti-cellulite creams, skin care creams, tonics, anticellulitic complete treatments.

The most suitable product range for SPA and care centers.....when beauty emerges from nature.

Cosmetice naturale pentru o stare de bine. / Natural cosmetics for wellbeing.

FETE DE MASA / TABLE CLOTHES HUSE DE STAUN / CHAIR COVERS

Damasc Jacquard / Damask Jacquard



Tesaturi de calitate superioara in nuante rafinate. / High quality fabrics in refined shades.

FETE DE MASA / TABLE CLOTHES

Jacquard / Jacquard

Compozitie tesatura: poliester 100%/ Fabric blend: 100% Polyester

RESTAURANT



■ FATA DE MASA MINERVA

Fata de masa cu un aspect rafinat datorita tesaturii Jacquard si modelului stilizat. Fata de masa Jacquard este fabricata din tesatura poliester 100%, cu dimensiunile standard sau la comanda, orice dimensiune. Greutatea tesaturii este de 220gr/mp.

AVANTAJE : Tesatura fina, lucioasa si eleganta, se preteaza perfect pentru dotarea saloanelor de evenimente conferind un aspect festiv, se intretine foarte usor.

■ MINERVA TABLE CLOTH

Tablecloth with a refined appearance due Jacquard fabric and stylized model . Tablecloth Jacquard is made of 100 % polyester with standard or custom sizes. Weight fabric is 220 g / sqm.

ADVANTAGES : The fabric is soft, shiny and elegant, and perfect fit for events with its festive look. It is easy to care.



Exclusiv la
Domiseto®



MOSTRA
GRATUITA

3
ANI
GARANTIE



FETE DE MASA / TABLE CLOTHES

Jacquard / Jacquard

Tesatura: poliester 100%/Fabric blend: 100% Polyester

RESTAURANT



■ FATA DE MASA RETRO

Fata de masa are un aspect rafinat datorita tesaturii Jacquard si modelului elegant din tesatura. Fata de masa Jacquard este fabricata din tesatura poliester 100%, cu dimensiunile standard sau la comanda, orice dimensiune. Greutatea tesaturii este de 220gr/mp.

AVANTAJE : Tesatura fina, lucioasa si eleganta, se preteaza perfect pentru dotarea saloanelor de evenimente conferind un aspect festiv, se intretine foarte usor.

■ RETRO TABLE CLOTH

Tablecloth with a refined appearance due Jacquard fabric and elegant pattern . Tablecloth Jacquard is made of 100 % polyester with standard or custom sizes . Weight fabric is 220 g / sqm.

ADVANTAGES : The fabric is soft, shiny and elegant, and perfect fit for events with its festive look. It is easy to care.



Exclusiv la
Domiseto®



MOSTRA
GRATUITA

3
ANI
GARANTIE



FETE DE MASA / TABLE CLOTHES

Jacquard / Jacquard

Tesatura: poliester 100%/Fabric blend: 100% Polyester

RESTAURANT

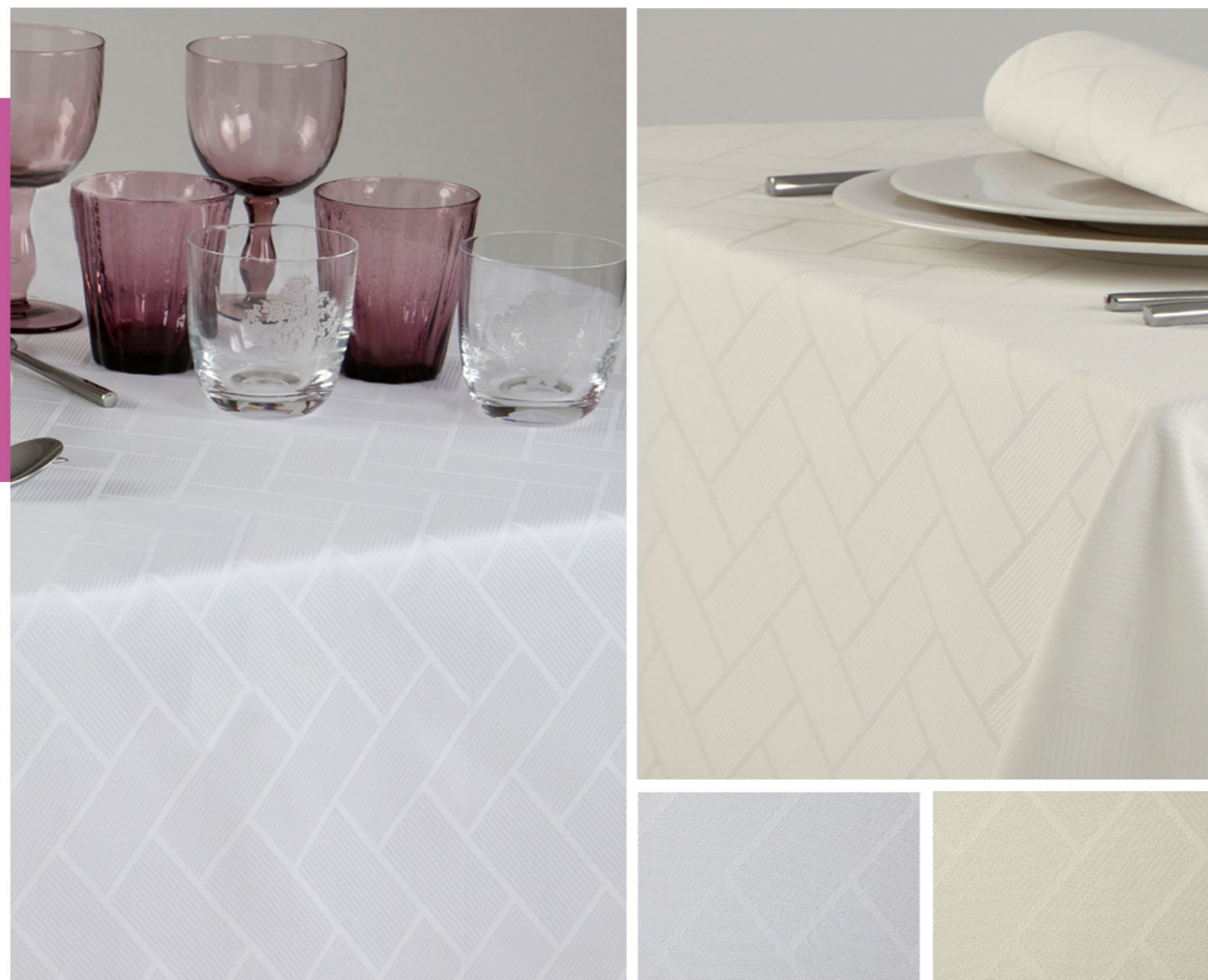

■ FATA DE MASA TARBES

Fata de masa are un aspect rafinat datorita tesaturii Jacquard si modelului din tesatura. Fata de masa Jacquard este fabricata din tesatura poliester 100%, cu dimensiunile standard sau la comanda, orice dimensiune. Greutatea tesaturii este de 220gr/mp.

AVANTAJE : Tesatura fina, lucioasa si eleganta, se preteaza perfect pentru dotarea saloanelor de evenimente conferind un aspect festiv, se intretine foarte usor.

■ TARBES TABLE CLOTH

Tablecloth with a refined appearance due Jacquard fabric and discrete grunge pattern . Tablecloth Jaquard is made of 100 % polyester with standard or custom sizes .
Weight fabric is 220 g / sqm.

ADVANTAGES : The fabric is soft, shiny and elegant, and perfect fit for events with its festive look. It is easy to care.



Exclusiv la
Domiseto®

Fabricat in
România

MOSTRA
GRATUITA

3
ANI
GARANTIE

CONFIDENCE
IN TEXTILES
Tested for harmful substances
according to Oeko-Tex® Standard 100
02.T.2249
Hohenstein

FETE DE MASA / TABLE CLOTHES

Jacquard / Jacquard

Tesatura: poliester 100%/Fabric blend: 100% Polyester

RESTAURANT



■ FATA DE MASA ABACANTO

Fata de masa are un aspect rafinat datorita tesaturii Jacquard si modelului din tesatura. Fata de masa Jacquard este fabricata din tesatura poliester 100%, cu dimensiunile standard sau la comanda, orice dimensiune. Greutatea tesaturii este de 220gr/mp.

AVANTAJE : Tesatura fina, lucioasa si eleganta, se preteaza perfect pentru dotarea saloanelor de evenimente conferind un aspect festiv, se intretine foarte usor.

■ ABACANTO TABLE CLOTH

Tablecloth with a refined appearance due Jacquard fabric and discrete grunge pattern . Tablecloth Jaquard is made of 100 % polyester with standard or custom sizes .
Weight fabric is 220 g / sqm.

ADVANTAGES : The fabric is soft, shiny and elegant, and perfect fit for events with its festive look. It is easy to care.



Exclusiv la
Domiseto®

Fabricat in
România

MOSTRA
GRATUITA

3
ANI
GARANTIE

CONFIDENCE
IN TEXTILES
Tested for harmful substances
according to Oeko-Tex® Standard 100
02.T.2249
Hohenstein

○ acuratete estetica desavarsita! / Accuracy perfect aesthetics!

○ acuratete estetica desavarsita! / Accuracy perfect aesthetics!

FETE DE MASA / TABLE CLOTHES

Satin / Satin

Tesatura: poliester 100% / Fabric blend: 100% Polyester



RESTAURANT

■ FATA DE MASA SATIN

Datorita aspectul sau impecabil si satinat, tesatura lucioasa Satin impune o eleganta estetica desavarsita. Fata de masa este fabricata din tesatura poliester 100%, cu dimensiunile standard sau la comanda, orice dimensiune. Greutatea tesaturii este de 225gr/mp.

AVANTAJE : Tesatura fina si eleganta, se preteaza perfect pentru dotarea saloanelor de evenimente conferind un aspect festiv, se intretine foarte usor.

■ SATIN TABLE CLOTH

Thanks to impeccable appearance and satin, glossy Satin fabric requires a perfect aesthetic elegance. Tablecloth is made of 100 % polyester with standard or custom sizes . Weight fabric is 225 g / sqm.

ADVANTAGES : The fabric is soft, shiny and elegant, and perfect fit for events with its festive look. It is easy to care.



Exclusiv la
Domiseto®



MOSTRA
GRATUITA

3
ANI
GARANTIE



FETE DE MASA / TABLE CLOTHES

Jacquard / Jacquard

Tesatura: bumbac 50%, poliester 50%/Fabric blend: 50% Polyester, 50% Cotton



RESTAURANT

■ FATA DE MASA CANNES

Fata de masa are un aspect rafinat datorita tesaturii Jacquard si modelului discret. Fata de masa Jacquard este fabricata din tesatura bumbac 50% si poliester 50%, cu dimensiunile standard sau la comanda, orice dimensiune. Greutatea tesaturii este de 240gr/mp.

AVANTAJE : Tesatura fina, lucioasa si eleganta, se preteaza perfect pentru dotarea saloanelor de evenimente conferind un aspect festiv, se intretine foarte usor.

■ CANNES TABLE CLOTH

Tablecloth with a refined appearance due Jacquard fabric and discrete model . Tablecloth Jacquard is made of cotton 50 % and 50 % polyester with standard or custom sizes . Weight fabric is 240 g / sqm.

ADVANTAGES : The fabric is soft, shiny and elegant, and perfect fit for events with its festive look. It is easy to care.



Exclusiv la
Domiseto®



MOSTRA
GRATUITA

3
ANI
GARANTIE



FETE DE MASA / TABLE CLOTHES

Jacquard / Jacquard

Tesatura: bumbac 50%, poliester 50%/Fabric blend: 50% Polyester, 50% Cotton

RESTAURANT



■ FATA DE MASA OLIMPIA

Fata de masa Olimpia de culoare alba, din tesatura Jacquard cu model format din buchetele de flori. Fata de masa Jacquard este fabricata din tesatura bumbac 50% si poliester 50%, cu dimensiunile standard sau la comanda, orice dimensiune. Greutatea tesaturii este de 180gr/mp.

AVANTAJE : Tesatura fina, lucioasa si eleganta, se preteaza perfect pentru dotarea saloanelor de evenimente conferind un aspect festiv, se intretine foarte usor.

■ OLIMPIA TABLE CLOTH

Tablecloth with a refined appearance due Jacquard fabric and discrete flower bouquets pattern . Tablecloth Jacquard is made of cotton 50 % and 50 % polyester with standard or custom sizes . Weight fabric is 180 g / sqm.

ADVANTAGES : The fabric is soft, shiny and elegant, and perfect fit for events with its festive look. It is easy to care.



Exclusiv la
Domiseto



MOSTRA
GRATUITA

3
ANI
GARANTIE



FETE DE MASA / TABLE CLOTHES

Jacquard / Jacquard

Tesatura: bumbac 50%, poliester 50%/Fabric blend: 50% Polyester, 50% Cotton

RESTAURANT



■ FATA DE MASA ALHAMBRA

Fata de masa are un aspect rafinat datorita tesaturii Jacquard si modelului cu frunze. Fata de masa Jacquard este fabricata din tesatura bumbac 50% si poliester 50%, cu dimensiunile standard sau la comanda, orice dimensiune. Greutatea tesaturii este de 240gr/mp.

AVANTAJE : Tesatura fina, lucioasa si eleganta, se preteaza perfect pentru dotarea saloanelor de evenimente conferind un aspect festiv, se intretine foarte usor.

■ ALHAMBRA TABLE CLOTH

Tablecloth with a refined appearance due Jacquard fabric and discrete leaf pattern . Tablecloth Jacquard is made of cotton 50 % and 50 % polyester with standard or custom sizes . Weight fabric is 240 g / sqm.

ADVANTAGES : The fabric is soft, shiny and elegant, and perfect fit for events with its festive look. It is easy to care.



Exclusiv la
Domiseto



MOSTRA
GRATUITA

3
ANI
GARANTIE



FETE DE MASA / TABLE CLOTHES

Jacquard / Jacquard

Tesatura: bumbac 40%, poliester 60%/Fabric blend: 40% cotton,60% Polyester

RESTAURANT



■ FATA DE MASA TOPO

Fata de masa are un aspect rafinat datorita tesaturii Jacquard si modelului cu buline din tesatura. Fata de masa Jacquard este fabricata din tesatura din bumbac 40% si poliester 60%, cu dimensiunile standard sau la comanda, orice dimensiune. Greutatea tesaturii este de 230gr/mp.

AVANTAJE : Tesatura fina, lucioasa si eleganta, se preteaza perfect pentru dotarea saloanelor de evenimente conferind un aspect festiv, se intretine foarte usor.

■ TOPO TABLE CLOTH

Tablecloth with a refined appearance due Jacquard fabric and discrete polka dot pattern . Tablecloth Jaquard is fabric made of 40% cotton, 60 % polyester with standard or custom sizes . Weight fabric is 230 g / sqm.

ADVANTAGES : The fabric is soft, shiny and elegant, and perfect fit for events with its festive look. It is easy to care.



Exclusiv la
Domiseto®



MOSTRA
GRATUITA

3
ANI
GARANTIE



FETE DE MASA / TABLE CLOTHES

Jacquard / Jacquard

Tesatura: bumbac 40%, poliester 60%/Fabric blend: 40% cotton,60% Polyester

RESTAURANT



NOU !

■ FATA DE MASA VINTAGE

Fata de masa are un aspect rafinat datorita tesaturii Jacquard cu modele florale si geometrice coordonate. Fata de masa Jacquard este fabricata din tesatura din bumbac 40% si poliester 60%, cu dimensiunile standard sau la comanda, orice dimensiune. Greutatea tesaturii este de 230gr/mp.

AVANTAJE : Tesatura fina, lucioasa si eleganta, se preteaza perfect pentru dotarea saloanelor de evenimente conferind un aspect festiv, se intretine foarte usor.

■ VINTAGE TABLE CLOTH

Tablecloth with a refined appearance due Jacquard fabric and beautiful floral and geometric pattern . Tablecloth Jaquard is fabric made of 40% cotton, 60 % polyester with standard or custom sizes . Weight fabric is 230 g / sqm.

ADVANTAGES : The fabric is soft, shiny and elegant, and perfect fit for events with its festive look. It is easy to care.



Exclusiv la
Domiseto®



MOSTRA
GRATUITA

3
ANI
GARANTIE



FETE DE MASA / TABLE CLOTHES

Jacquard / Jacquard

Tesatura: bumbac 30%, poliester 70%/Fabric blend: 30% cotton, 70%Polyester



■ FATA DE MASA SUBWAY

Fata de masa are un aspect rafinat datorita tesaturii Jacquard si modelului lineal din tesatura. Fata de masa Jacquard este fabricata din tesatura din bumbac 30% si poliester 70%, cu dimensiunile standard sau la comanda, orice dimensiune. Greutatea tesaturii este de 230gr/mp.

AVANTAJE : Tesatura fina, lucioasa si eleganta, se preteaza perfect pentru dotarea saloanelor de evenimente conferind un aspect festiv, se intretine foarte usor.

■ SUBWAY TABLE CLOTH

Tablecloth with a refined appearance due Jacquard fabric and discrete stripes pattern . Tablecloth Jaquard is made of 30% cotton, 70 % polyester with standard or custom sizes . Weight fabric is 230 g / sqm.

ADVANTAGES : The fabric is soft, shiny and elegant, and perfect fit for events with its festive look. It is easy to care.



Exclusiv la
Domiseto®



MOSTRA
GRATUITA

3
ANI
GARANTIE



FETE DE MASA / TABLE CLOTHES

Damasc / Damask

Tesatura: bumbac 48%,poliester 52%/Fabric blend: 48% cotton,52% Polyester



■ FATA DE MASA DAMASC

Tesatura de calitate superioara, confectionata din Damasc. Fata de masa este fabricata din tesatura de bumbac 48% si poliester 52%, cu dimensiunile standard sau la comanda, orice dimensiune. Greutatea tesaturii este de 247gr/mp. si o toleranta dimensionala de 2 cm.

AVANTAJE : Tesatura fina, mata si eleganta, se preteaza perfect pentru dotarea saloanelor de evenimente conferind un aspect festiv, se intretine foarte usor.

■ DAMASK TABLE CLOTH

High quality fabric , made of Damask. Tablecloth made of cotton 48 % and 52 % polyester fabric , with fabric weight of 247 g / sqm and a dimensional tolerance 2 cm . This particular product are made only order various sizes .

ADVANTAGES : The fabric is soft, shiny and elegant, and perfect fit for events with its festive look. It is easy to care.



Exclusiv la
Domiseto®



MOSTRA
GRATUITA

3
ANI
GARANTIE



Detalii tehnice / Technic details

Tipuri de fete de masa / Tablecloth types

RESTAURANT

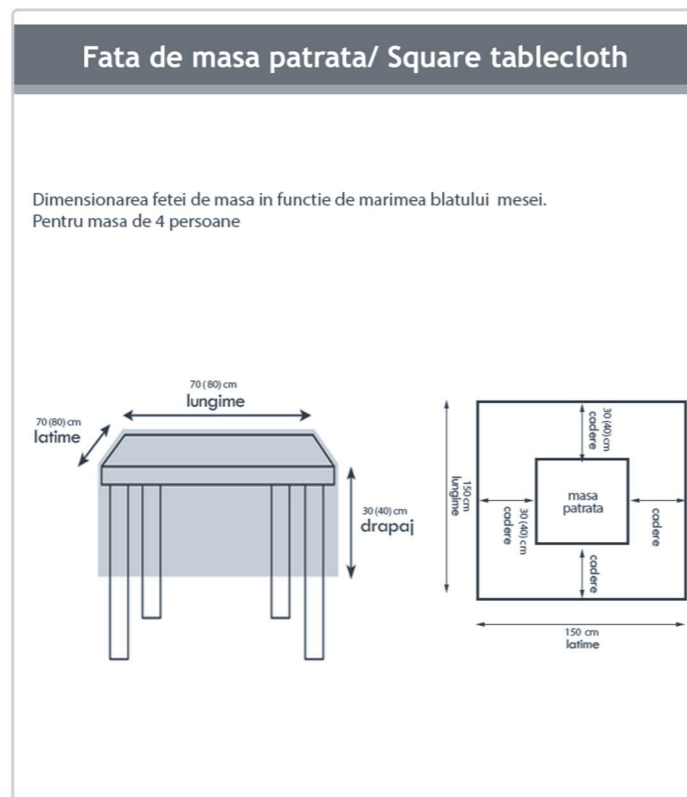
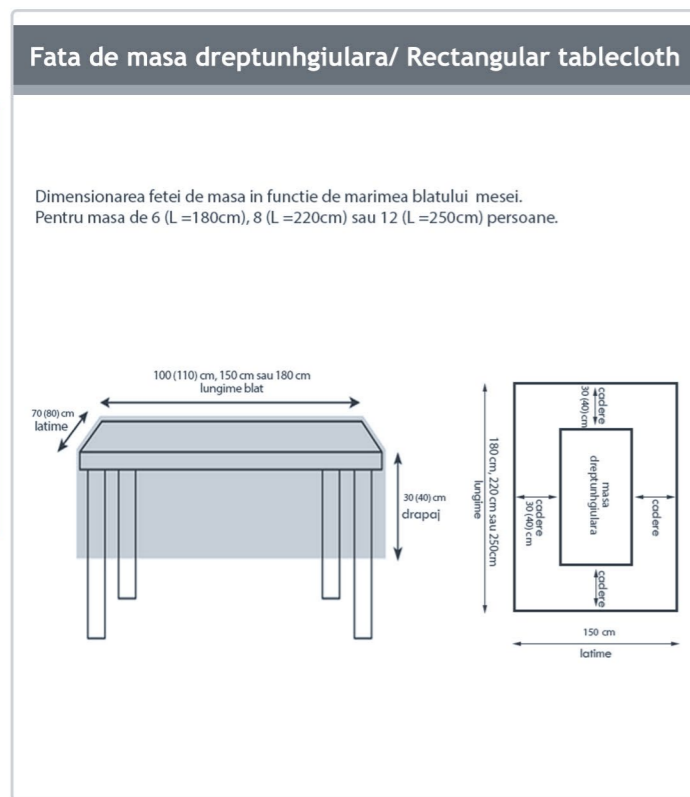

AVANTAJE :

Tesaturile folosite la confectionarea fetelor de masa, naproane, runnere, servete, etc. Sunt Damasc si satin Plain sau Jaquard de cea mai buna calitate, cu finisaj special pentru uz intensiv, culori rezistente la spalari multiple, se calca usor. Fiind fabricate la latime mare 320cm, permit confectionarea pieselor cu dimensiuni mari (ex. Fata masa rotunda diametru 310cm, fileuri). Paleta coloristica este foarte variata permitand combinarea culorilor pentru obtinerea unui efect decorativ

ADVANTAGES :

The fabrics proposed for tablecloths, aprons, runners, napkins, are Damasc and Satin Plain and Jaquard and are of the highest quality with special finishing for intensive use, colors resistant to multiple washings and easy care. Being manufactured in large size table clothes (ex. round table 310cm diameter, wide widths). The color palette is varied allowing to mix colors to obtain a special decorative effect.

HUSE DE SACAUN / CHAIR COVERS

Damasc Jacquard / Damask Jacquard



RESTAURANT

■ HUSE DE SCAUN

Confectionate din tesaturi cu finisaje speciale pentru uz profesional, Damasc Jacquard, Satin Plain, tesaturi elastice sau rigide 100% poliester, intr-o varietate mare de culori si modele, husele de scaun completeaza decorul salonului de evenimente, oferindu-i o nota personala.

AVANTAJE : Suntem in masura sa va oferim posibilitatea fabricarii la comanda a huselor de scaun pe modelul scaunelor din dotare si a completarii decorului cu funde, banderole.

■ CHAIR COVERS

Made of different Polycotton fabrics with special finishes for professional use, Damask Jacquard, Satin Plain, 100% polyester fabrics elastic or rigid in a wide variety of colors and patterns, the chair covers compete the decoration of your event, adding to your restaurant a personal touch.

ADVANTAGES : We are able to offer you the possibility of custom made chair covers perfect fitted to the chair either shape or moder of your chairs. We can complete the decoration by adding bows and scarfs.



Exclusiv la
Domiseto

Fabricat in
Romania

MOSTRA
GRATUITA

3
ANI
GARANTIE

CONFIDENCE
IN TEXTILES
Tested for harmful substances
according to Oeko-Tex® Standard 100
02.T.2249
Hohenstein

DIMENSIUNI / SIZES

Lenjerii de pat tip "hotel" / Hotel bed sets

ARTICOL ARTICLE	PAT 1 PERSOANA SINGLE BED SET 80-100X200 cm	PAT 2 PERSOANE DOUBLE BED SET 140-160X200 cm	PAT MATRIMONIAL MATRIMONIAL BED SET 180-200X200 cm
Cearceaf pat Flat bed sheet	160x280 cm	220x280 cm	240x280 cm
Husa pat cu elastic Fitted sheet	80-100x200+30 cm	140-160x200+30 cm	180-200x200+30 cm
Husa pilota Duvet cover	140X200+30 cm flap 150x210+30 cm flap	190-x220+30 cm flap 180x210+30 cm flap	220x200+30 cm flap 220x240+30 cm flap
Fata de perna Pillow case	70X70+25 cm flap 50x70+25 cm flap 40x40+15 cm flap	70X70+25 cm flap 50x70+25 cm flap 40x40+15 cm flap	70X70+25 cm flap 50x70+25 cm flap 40x40+15 cm flap

Inchidere cu flap / Flap closure

Se pot fabrica la comanda orice dimensiuni/ Tailoring by costumer size

Pilote matlasate, perne antialergice/ Quilted duvets, antialergic pillows

Pilote matlasate Quilted duvets	140x200 cm 150x210 cm	180x210 cm 190x220 cm	220x200 cm 240x220 cm
Perne antialergice microfibra Microfiber antialergic pillow	40x40 cm 50x50 cm 70x70 cm	40x40 cm 50x50 cm 70x70 cm	40x40 cm 50x50 cm 70x70 cm

Se pot fabrica la comanda orice dimensiuni/ Tailoring by costumer size

Huse matlasate si impermeabile protectie saltea Quilted and waterproof protection mattresses

Husa matlasata Quilted protection	80-100x200 cm	140-160x200 cm	180-200x200 cm
Husa impermeabila Waterproof protection	80-100x200+20 cm	140-160x200 cm	180-200x200+20 cm

Se pot fabrica la comanda orice dimensiuni/ Tailoring by costumer size

DIMENSIUNI / SIZES

Prosoape, covorase si halate de baie/ Bath towels, mats and robes

ARTICOL ARTICLE	DIMENSIUNE SIZE
Prosop maini Hand towel	30x50 cm
Prosop fata Face towel	50x90 cm
Prosop baie Bath towel	70x140 cm
Prosop Spa & sauna Spa & sauna towel	100x150 cm
Prosop plaja & piscina Beach & pool towel	70x140 cm, 100/150 cm, 10/200 cm
Covorase baie Bath mat	50x70 cm
Halat baie Velour cu guler SHAL, 450 gr./mp Velour Bath robe with SHAWL collar	L, XL,
Halat baie Frottier cu guler SHAL, 420 gr./mp Frottier Bath robe with SHAWL collar	L, XL,
Halat baie Frottier cu guler Kimono, 360 gr./mp Frottier Bath robe with Kimono collar	L, XL,
Halat baie Pique cu guler Kimono, 260 gr./mp Waffle Bath robe with Kimono collar	L, XL,
Fusta prosop sauna & SPA Wrap for Spa	L, XL
Papuci de baie Bath slippers	masura unica one size

Simboluri de intretinere textile hoteliere/ Hotel textiles care instructions

100% bumbac satin dungii si plain (Scala, Elina, Triana) 100% Cotton satin stripes and plain (Scala, Elina, Triana)					
100% bumbac Percal, Renforce (Chandy) 100% Cotton Percal, Renforce (Chandy)					
50% bumbac 50% poliester satin dungii (Corsica) 50% Cotton 50% Polyester satin stripes (Corsica)					
50% bumbac 50% poliester Percal (Onda) 50% Cotton 50% Polyester Percal (Onda)					
Pilote, huse protectie saltea, perne antialergice Duvets, mattress protectors, antialergic pillows					
Prosoape, covorase, halate de baie Velour, Frottier 100% bumbac alb Towels, bath mats, bath robes 100% Cotton					



MOD-ELLE COMPANY SRL

România, București
Sos. Vergului nr.18, sector 2,
Cod poștal 02248



MARKETING/VÂNZĂRI

Tel: +40 21.255.07.22
Fax: +40 21.255.68.36
Mobil: +40 757.106.600



E-MAIL/WEBSITE

office@cottonissima.com
marketing@dormisete.ro
www.cottonissima.com

